

.....

•

Notice

The information in this guide is subject to change without notice.

COMPAQ COMPUTER CORPORATION SHALL NOT BE LIABLE FOR TECHNICAL OR EDITORIAL ERRORS OR OMISSIONS CONTAINED HEREIN; NOR FOR INCIDENTAL OR CONSEQUENTIAL DAMAGES RESULTING FROM THE FURNISHING, PERFORMANCE, OR USE OF THIS MATERIAL.

This guide contains information protected by copyright. No part of this guide may be photocopied or reproduced in any form without prior written consent from Compaq Computer Corporation.

© 1997 Compaq Computer Corporation.
All rights reserved. Printed in the U.S.A.

Compaq, LTE, Contura, ProLinea, QuickLock, QuickBlank are registered in the U. S. Patent and Trademark Office. Armada is a trademark of Compaq Computer Corporation.

Contura is registered in the Philippines Patent Office.

Microsoft, MS-DOS, and Windows are registered trademarks of Microsoft Corporation. Windows 95 is a trademark of Microsoft Corporation.

The software described in this guide is furnished under a license agreement or nondisclosure agreement. The software may be used or copied only in accordance with the terms of the agreement. Product names mentioned herein may be trademarks and/or registered trademarks of their respective companies.

Maintenance and Service Guide

Compaq Armada 1500 Family of Personal Computers

First Edition (March 1997)
Spare Part Number 255011-001
Document Part Number 284820-001

Compaq Computer Corporation

Preface

This *Maintenance and Service Guide* is a troubleshooting guide that can be used for reference when servicing the Compaq Armada 1500 Family of Personal Computers. Additional information is available in the *Service Quick Reference Guide* and in *QuickFind*.

Compaq Computer Corporation reserves the right to make changes to the Compaq Armada 1500 Personal Computers without notice.

Symbols

The following symbols and words mark special messages throughout this guide:



WARNING: Text set off in this manner indicates that failure to follow directions in the warning could result in bodily harm or loss of life.



CAUTION: Text set off in this manner indicates that failure to follow directions could result in damage to equipment or loss of data.

IMPORTANT: Text set off in this manner presents clarifying information or specific instructions.

NOTE: Text set off in this manner presents commentary, sidelights, or other points of information.

Technician Notes



WARNING: Only authorized technicians trained by Compaq should attempt to repair this equipment. All troubleshooting and repair procedures are detailed to allow only subassembly/module level repair. Because of the complexity of the individual boards and subassemblies, no one should attempt to make repairs at the component level or to make modifications to any printed wiring board. Improper repairs can create a safety hazard. Any indication of component replacement or printed wiring board modifications may void any warranty or exchange allowances.



CAUTION: To properly ventilate the system being serviced, you must provide at least 3 inches (7.62 cm) of clearance on the front and back of the computer.



WARNING: The computer is designed to be electrically grounded. To ensure proper operation, plug the AC power cord into a properly grounded electrical outlet only.

Laser Safety

All Compaq systems, equipped with CD-ROM drives, comply with appropriate safety standard including IEC 825. With specific regard to the laser, the equipment complies with laser product performance standards set by government agencies as a Class 1 laser product. It does not emit hazardous light; the beam is totally enclosed during all modes of customer operation and maintenance.

CDRH Regulations

The Center for Devices and Radiological Health (CDRH) of the U.S. Food and Drug Administration implemented regulations for laser products on August 2, 1976. These regulations apply to laser products manufactured from August 1, 1976. Compliance is mandatory for products marketed in the United States.



WARNING: Use of controls or adjustments or performance of procedures other than those specified herein or in the CD ROM installation guide may result in hazardous radiation exposure.



This system is classified as a CLASS 1 LASER PRODUCT. This label is located on the outside of the system being serviced. A similar label also appears on the internal CD-ROM installed in the system.

LASER INFO

Laser Type:	Semiconductor GaAIAs
Wave Length:	780 +/- 35 nm
Divergence Angle:	53.5 Degree +/- 1.5 Degree
Output Power:	Less than 0.2mW or $10,869 \text{ W}\cdot\text{m}^{-2}\text{sr}^{-1}$
Polarization:	Circular
Numerical Aperture:	0.45 +/- 0.04

Only authorized technicians, service provider, dealer, or reseller should attempt to repair this equipment. All troubleshooting and repair procedures are detailed to allow only subassembly/module level repair. Because of the complexity of the individual boards and subassemblies, no one should attempt to make repairs at the component level or to make modifications to any printed wiring board. Improper repairs can create a safety hazard as well as void the warranty.

.....

•

Battery Notice

This computer contains an internal lithium battery-powered real-time clock circuit. There is a risk of explosion and injury if the battery is incorrectly replaced or handled improperly. Do not attempt to recharge, disassemble, immerse in water, or dispose of it in fire. Replacement should be done using the Compaq spare part for this computer.

The computer also contains a nickel metal hydride or lithium-ion battery pack. There is a risk of fire and chemical burn if the battery pack is handled improperly. Do not disassemble, crush, puncture, short external contacts, dispose in fire or water, or expose it to temperatures higher than 60 degrees C.

In North America, dispose of nickel metal hydride or lithium-ion batteries by taking advantage of the Compaq battery recycling program. You will be provided with a postage-paid battery pack mailer preaddressed to a reclamation facility where the metals are recycled.

In Europe, do not dispose of batteries and accumulators with general household waste. Dispose of or recycle them by using the public collection system or returning them to Compaq.

Serial Number

The serial number is located on the back of the computer directly below the parallel connector.

.....

■

Locating Additional Information

The following documentation is available to support the products:

- *Quick Setup*
- *Reference Guide*
- *Introducing Microsoft Windows 95*
- *Compaq Service Quick Reference Guide*
- Service Training Guides
- Compaq Service Advisories and Bulletins
- *Compaq QuickFind*
- *Technical Reference Guide*

Contents

Preface

Symbols	xi
Technician Notes	xi
Laser Safety	xii
CDRH Regulations	xii
Battery Notice	xiii
Serial Number	xiii
Locating Additional Information	xiv

Chapter 1 **Computer Product Description**

1.1 Computer Features and Models	1-1
1.2 Standard Features	1-2
1.2.1 Software Fulfillment	1-3
1.3 Options	1-4
1.3.1 Convenience Base	1-4
1.3.2 System Memory Options	1-4
1.3.3 External Battery Charger	1-5
1.3.4 External Keyboards and Pointing Devices	1-5
1.3.5 External Monitors	1-5
1.4 External Computer Components	1-6
1.4.1 Front and Left Side Components	1-6
1.4.2 Right Side Components	1-7
1.4.3 Rear Components	1-8
1.4.4 Bottom Components	1-9
1.4.5 Status Panel Lights	1-10

Chapter 2 **Convenience Base Description**

2.1 Models and Features	2-1
2.2 Convenience Base Features	2-3
2.3 Convenience Base Components	2-4
2.3.1 Front and Right Side Components	2-4
2.3.2 Rear Components	2-6

.....

Chapter 3 **Troubleshooting**

3.1 Preliminary Steps	3-2
3.2 Clearing the Power-On and Setup Passwords	3-3
3.3 Power-On Self Test (POST)	3-4
3.4 POST Error Messages	3-4
3.5 Compaq Utilities	3-7
Running Computer Setup	3-7
Running Computer Checkup (TEST)	3-8
View System Information (INSPECT)	3-10
3.6 Diagnostic Error Codes	3-11
3.7 Troubleshooting Without Diagnostics	3-17
3.7.1 Solving Minor Problems	3-17

Chapter 4 **Illustrated Parts for the Computer**

4.1 System Unit	4-2
4.2 Mass Storage Devices	4-4
4.3 Cables and Power Cords	4-6
4.4 Standard and Optional Boards	4-8
4.5 Options	4-10
4.6 Miscellaneous Parts	4-12
4.8 Shipping Boxes	4-14
4.9 Documentation	4-14

Chapter 5 **Illustrated Parts for the Convenience Base**

5.1 System Unit	5-2
-----------------	-----

Chapter 6 **Removal and Replacement Preliminaries**

6.1 Electrostatic Discharge	6-1
Generating Static	6-1
Preventing Electrostatic Damage to Equipment	6-2
Removing Batteries	6-2
Preventing Damage to Drives	6-3

Grounding Methods	6-3
Grounding Workstations	6-4
Grounding Equipment	6-4
Recommended Materials and Equipment	6-5
6.2 Service Considerations	6-6
Tool Requirements	6-6
Cables and Connectors	6-6
6.3 Serial Number	6-6

Chapter 7 **Computer Removal and Replacement Procedures**

7.1 Serial Number	7-1
7.2 Disassembly Sequence Chart	7-2
7.3 Design Overview	7-3
7.3.1 System Unit	7-3
7.3.2 Internal Boards	7-3
7.3.3 Video system	7-4
7.4 Preparing the Computer for Disassembly	7-5
7.4.1 Disconnecting the AC Power	7-5
7.4.2 Undocking the Computer	7-5
7.4.3 Battery Pack	7-6
7.4.4 DualBay Devices	7-8
7.4.5 PCMCIA	7-9
7.5 Modem	7-10
7.6 CD-ROM Drive	7-11
7.7 Keyboard	7-13
7.8 Memory Board	7-16
7.9 Hard Drive	7-19
7.10 Lithium Real Time Clock Battery	7-21
7.11 Microphone/Display Cable Cover and Microphone	7-23
7.12 Clutch Covers/Display Assembly	7-26
7.12.1 Clutch Covers	7-26
7.12.2 Display Assembly	7-27
7.12.3 Clutches	7-28
7.12.4 Display latches	7-32

7.13 Top Cover Assembly	7-34
7.13.1 Power Button	7-36
7.13.2 Suspend Button	7-37
7.13.3 Left and Right Touchpad Buttons	7-38
7.14 LED Status Panel	7-40
7.15 Audio Board, Speakers, and Audio Cable	7-41
7.16 DC-DC Converter	7-43
7.17 Fan	7-47
7.18 I/O Fixture Connector	7-49
7.19 System Board	7-51
7.20 AC Power	7-53
7.21 External Computer Components	7-54
7.21.1 Computer Logo	7-54
7.21.2 Computer Feet	7-54

Chapter 8
Upgrade Procedures for the Convenience Base

8.1 Serial Number	8-1
8.2 Preliminary Procedure	8-1
8.2.1 Installing the Optional 100BaseT Ethernet Network Module	8-2

Chapter 9
Specifications

9.1 Computer	9-2
9.2 Displays	9-3
9.3 Hard Drives	9-4
9.4 Diskette Drive	9-5
9.5 CD-ROM Drive	9-6
9.6 Battery Packs	9-7
9.7 Convenience Base	9-8
9.8 External Power Supplies	9-9
9.9 System Interrupts	9-11
9.10 System DMA	9-11
9.11 System I/O Address	9-12
9.12 System Memory Map	9-14

<i>Appendix A</i>	
Comput	A-1
<hr/>	
<i>Appendix B</i>	
Power Cord Set Requirements	
3-Conductor Power Cord Set	B-1
General Requirements	B-1
Country-Specific Requirements	B-2
Notes:	B-2
<hr/>	
<i>Appendix C</i>	
Modem Commands	C-1
<hr/>	
Index	I-1
<hr/>	

Computer Product Description

1.1 Computer Features and Models

The Compaq Armada 1500 Family of Personal Computers is a line of multimedia notebook computers with advanced modularity, processors, and video graphics. This full-function, Pentium-based, family of notebook computers allows full desktop functionality and connectivity through the use of an optional Convenience Base. The following computer models are available:

**Table 1-1
Compaq Armada Personal Computers**

Model	Pentium Processor	Display	Hard Drive	Level 2 Cache	CD-ROM	Modem	Serial Configuration
1510	120-MHz	11.3-inch CSTN	1.0-GB				BM51
1510DM	120-MHz	11.3-inch CSTN	1.0-GB		■	■	BM52
1520	133-MHz	11.3-inch CSTN	1.0-GB	256-Kbyte			BM53
1520D	133-MHz	11.3-inch CSTN	1.0-GB	256-Kbyte	■		BM54
1520DM	133-MHz	11.3-inch CSTN	1.0-GB	256-Kbyte	■	■	BM55
1550T	133-MHz	12.1-inch CTFT	1.4-GB	256-Kbyte			BM56
1550DMT	133-MHz	12.1-inch CTFT	1.4-GB	256-Kbyte	■	■	BM57

NOTE: All models have 16-MB of standard memory, upgradable to 80-MB.



Figure 1-1. Compaq Armada Personal Computer

1.2 Standard Features

The Compaq Armada models have the following standard features:

- 120- or 133-MHz Pentium processors
- 16-MB of EDO dynamic random access memory (DRAM), expandable to 80 MB
- 1.4-GB or 1.0-GB, 2.5- inch with carrier, or 3-inch hard drive
- 11.3-inch Color Super Twist Nematic CSTN, or 12.1-inch Color Thin Film Transistor (CTFT) SVGA displays
- Supports Lithium Ion (Li-ion) and Nickel Metal Hydride (NiMH) modular battery packs
- SoundBlaster-compatible audio controller with internal stereo speakers and internal microphone
- Full-size 101 key compatible keyboard including 12 function keys, 8 cursor control keys, inverted-T cursor control keys, and embedded numeric keypad
- Four user-programmable keys
- Touchpad pointing device
- Operates from an internal battery pack, plus an optional battery pack in the DualBay, or integrated AC power that is compatible with domestic or international power sources
- Power management and security features

-
- Infrared interface for wireless communication with other IrDA-compliant devices at data rates up to 4 mb/sec
 - Two standard device slots that will accommodate two types I and II and one type III PC Cards, PCMCIA and CardBus cards; Compaq Telephony modem in the top slot and Zoomed-Video in the bottom slot
 - 176 pin expansion connector provides the interface to the convenience base options
 - Rear-panel ports provide connections for parallel and serial, external monitor, keyboard/mouse, and IrDA compliant infrared devices

1.2.1 Software Fulfillment

Replacement software may be ordered directly from Compaq Computer Corporation. Both the model and the serial numbers of the computer are needed to identify the specific software available.



1.3 Options

The computer supports the following options:

- Convenience Base pass through model
- Convenience Base with Ethernet
- Memory expansion boards
- Li-ion and NiMH battery packs
- Automobile Adapter
- External Battery Charger
- PCMCIA modem
- AC power cords for international travelers
- Hard drive upgrade
- Internal modem
- Internal CD-ROM drive

1.3.1 Convenience Base

Compaq Armada models support the following convenience base models:

- Convenience base pass through
- Convenience base with Ethernet (RJ-45 and BNC connectors); BNC connector not available in North America
- Convenience base with Ethernet (BNC connector); not available in North America

1.3.2 System Memory Options

The computer supports optional 8-, 16-, 32-, and 64-MB memory boards. The memory boards are 60 ns EDO RAM without parity. System memory can be expanded to 80-MB of DRAM depending on the model.

1.3.3 External Battery Charger

The External Battery charger has the following features:

- Two battery charge slots
- Accepts both NiMH and Li-ion modular batteries
- Charges one battery in 1.5 hours
- Charges two batteries in 3 hours

1.3.4 External Keyboards and Pointing Devices

Supports Compaq or Compaq compatible PS2 keyboards and pointing devices

1.3.5 External Monitors

The Compaq Armada models support all VGA Monitors up to 1024 x 768.

.....

1.4 External Computer Components

The external computer components are illustrated and described in this section.

1.4.1 Front and Left Side Components

The front and left side external components are shown in the following figure and identified in this section:

- 🔒 Display latches
- 💡 Battery charge light
- 💡 Power/Suspend light
- 📂 DualBay compartment
- 📂 PC Card slots
- 🗑️ PC Card eject levers
- 📶 RJ-11 port (on some models)

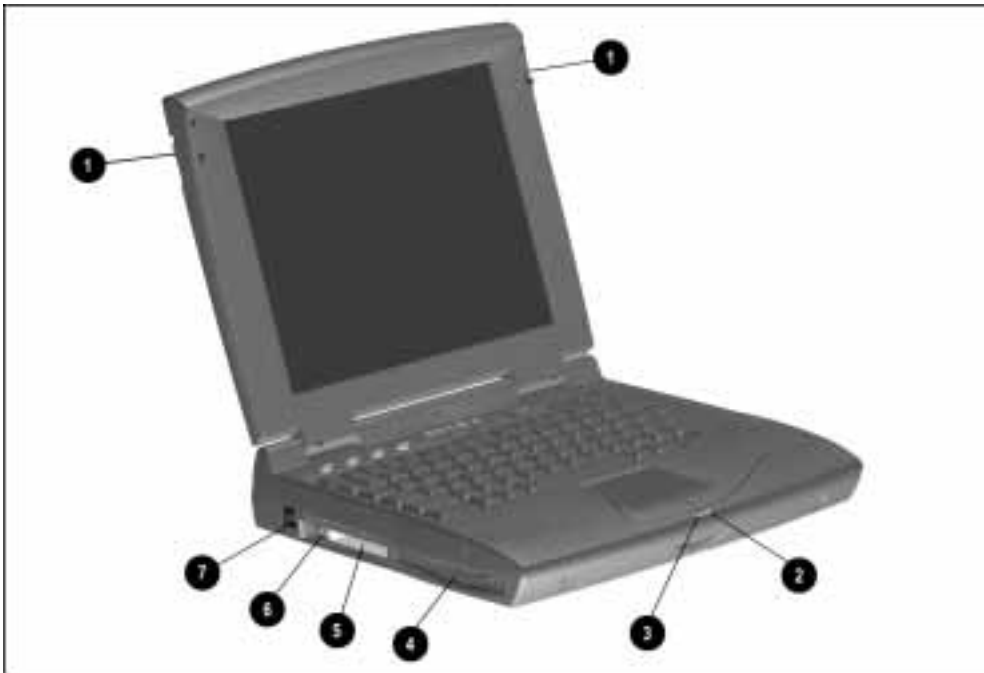

Figure 1-2. Front and Left Side Components

1.4.2 Right Side Components

The right side external components are shown in the following figure and identified in this section:

- 📁 Battery bay
- 🔊 Stereo/speaker headphone jack
- 🎤 Microphone jack
- 🔊 Volume control buttons
- 💿 CD-ROM drive (on some models)
- 🔒 Cable lock provision



Figure 1-3. Right Side Components

.....

1.4.3 Rear Components

The rear components are shown in the following figure and identified in this section:

- 📁 Serial connector
- 📄 Serial number
- 📄 Parallel connector
- 📄 External monitor connector
- 🔌 AC Power connector
- 🔌 Docking connector
- 🌀 Airflow vents
- 📡 Infrared port
- 🖱️ Keyboard/Mouse connector

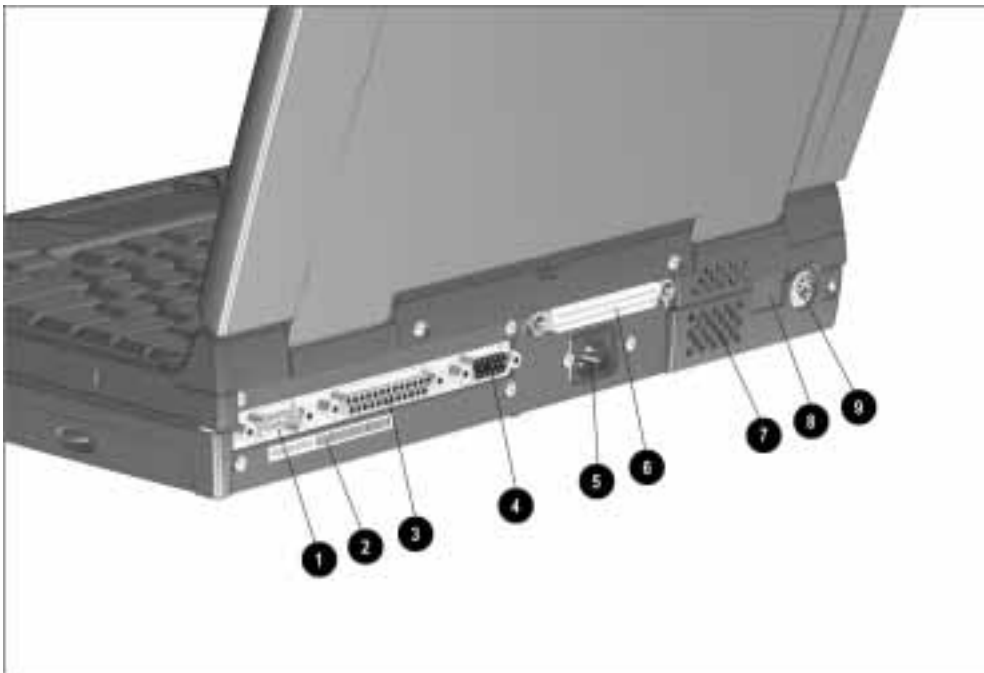



Figure 1-4. Rear Components

1.4.4 Bottom Components

The bottom external components are shown in the following figure and are identified in this section:

 Docking alignment guide

 Modem compartment

 Diskette drive

 Diskette drive release latch

 Docking latch receptacles

 Battery bay traction grip

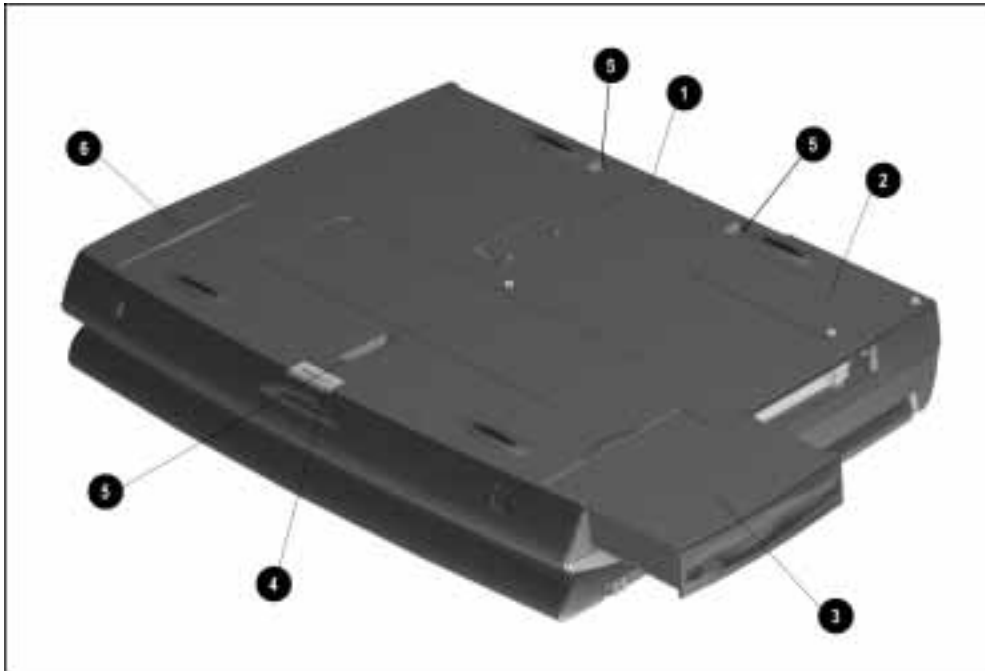

Figure 1-5. Bottom Components

.....

1.4.5 Status Panel Lights

The status panel lights are shown in the following figure and are identified in this section:

- ☐ Hard drive light
- ☐ Diskette drive light
- ☐ Num Lock light
- ☐ Caps Lock light
- ☐ Scroll Lock light



Figure 1-6. Status Panel Lights

Convenience Base Description

2.1 Models and Features

The convenience bases provide a permanent desktop solution for the computer by eliminating the need to disconnect external devices such as a printer, keyboard, or monitor when you undock the computer. All necessary connections and disconnections are made automatically when the computer is docked and undocked. The following convenience models are available:

Table 2-1
Compaq Armada 1500 Family of Convenience Bases

Model	Serial Configuration
Convenience Base Pass Through model	BNH3
Convenience Base with Ethernet	BNH1
Convenience Base with Ethernet, BNC model	BNH3



Figure 2-1. Compaq Armada 1500 Convenience Base

2.2 Convenience Base Features

The Convenience Base pass through model and the convenience base with Ethernet model include the following features:

	Convenience Base pass through	Convenience Base with Ethernet
Connections		
Speaker/headphone	■	■
Audio Line-In	■	■
Serial	■	■
Parallel	■	■
External Monitor	■	■
Keyboard	■	■
Pointing Device	■	■
MIDI/Joystick	■	■
Other Features		
Cable lock provision	■	■
Pass through AC Power	■	■
BNC connector (not available in all countries)		■
RJ-45 connector		■
Options		
Monitor Stand	■	■
Localized Power Cords	■	■
Kensington lock	■	■
Optional 100BaseT Ethernet Upgrade	■	■











.....

2.3 Convenience Base Components

The convenience base components are illustrated and described in this section.

2.3.1 Front and Right Side Components

The front and right side convenience base components are shown and identified in this section.

-  Power button
-  Security cable lock provision
-  Docking lever
-  Battery charge light
-  Suspend button
-  Power/Suspend light
-  Retaining latch
-  Pass through AC power outlet
-  Docking connector
-  Docking alignment pins
-  Docking latches

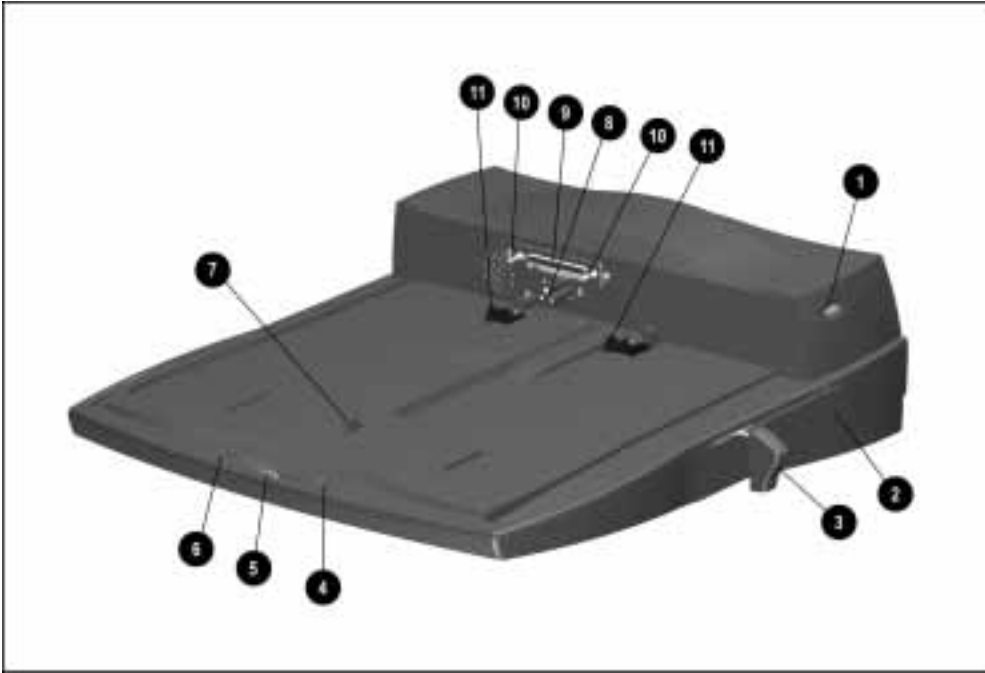



Figure 2-2. Convenience Base Front and Right Side Components

.....

2.3.2 Rear Components

The rear components are shown in the following figure and identified in this section:

 BNC connector (available on some models)

 RJ-45 jack

 Serial connector

 Parallel connector

 External monitor connector

 MIDI/Joystick connector

 Pointing device connector

 Keyboard connector

 Speaker/headphone jack

 Audio Line-in jack

 Fan

 AC power connector

.....

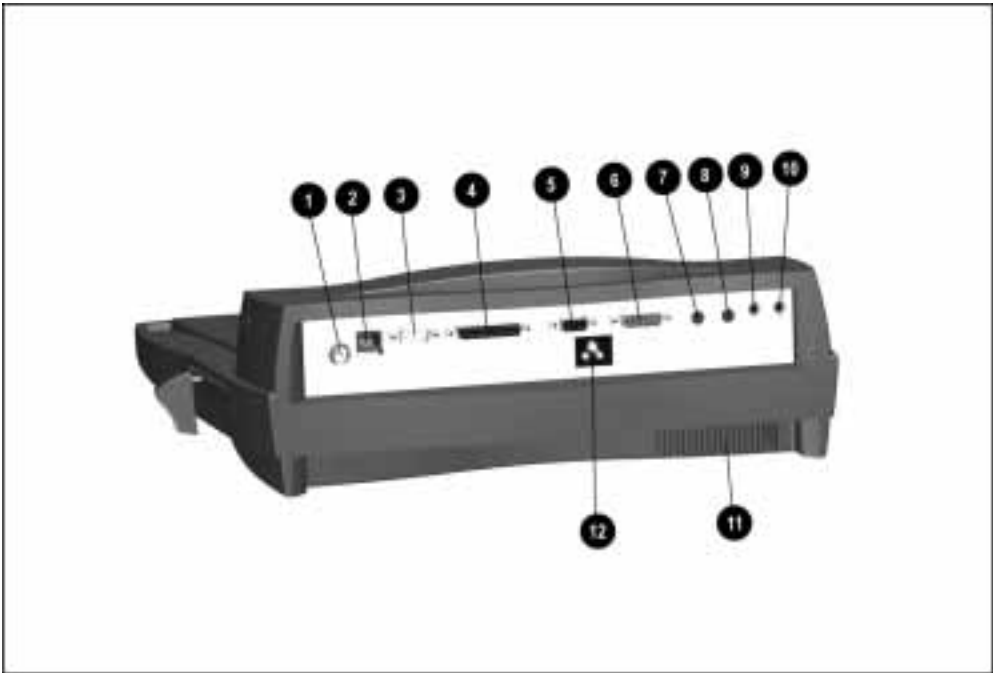

Figure 2-3. Convenience Base Rear Components

Troubleshooting

This chapter contains troubleshooting information for the computer and the convenience base. The basic steps in troubleshooting the computer include:

1. Completing the preliminary steps listed in Section 3.1.
2. Running the Power-On Self-Test (POST) as described in Section 3.3.
3. Running Computer Setup as described in Section 3.5
4. Running the Computer Checkup (TEST) as described in Section 3.5.
5. Performing the recommended actions described in the diagnostic tables in Section 3.6 if you are unable to exercise POST or Computer Checkup or if the problem persists after running POST and Computer Checkup.

Follow these guidelines when troubleshooting:

- Complete the recommended actions in the order in which they are given.
- Repeat POST and Computer Checkup after each recommended action until the problem is resolved and the error message does not return.
- Once the problem is resolved, do not complete the remaining recommended actions.
- Refer to Chapter 7 for any removal and replacement procedures that are recommended for the computer. Refer to Chapter 8 for any removal or replacement procedures that are recommended for the convenience base.
- If the problem is intermittent, check the computer or convenience base several times to verify that the problem is solved.

Use the following table for quick reference to troubleshooting information:

If You Want To:	Run:
Check for POST error messages	POST
Check that computer components are recognized and running properly	Computer Checkup (TEST) under Compaq Utilities
View information about the computer and installed or connected devices	View System Information (INSPECT) under Compaq Utilities
Perform any of the following: <ul style="list-style-type: none">■ Check the system configuration■ Set the system power management parameters■ Return the system to its original configuration■ Check system configuration of installed devices	Computer Setup

3.1 Preliminary Steps

IMPORTANT: Use AC Power when running POST, Computer Setup, or Computer Checkup. A low-battery condition could initiate Suspend or Hibernation and interrupt the test.

Before running POST and Computer Checkup, complete the following steps:

1. Obtain established passwords. If you must clear the passwords, go to Section 3.2.
2. Ensure that the hard drive is installed in the computer.
3. Ensure that the battery pack is installed in the computer and the AC power is connected to the computer and plugged into an AC power source.
4. Turn on the computer.
5. If a power-on password has been established, type the password and press **Enter**.

NOTE: The key icon appears on the display when the computer is turned on to indicate that QuickLock/QuickBlank has been initiated. Type the power-on password to exit QuickLock/QuickBlank. If the password is unknown, it must be cleared (see Section 3.2).

6. Run Computer Setup (Section 3.5).
7. Use the Hotkeys to adjust the contrast (**Fn+F9**) and brightness (**Fn+F10**) to the center of their ranges and leave the display open. On models with color TFT displays, contrast is not applicable.
8. Turn off the computer and all external devices.
9. Disconnect any external devices that you do not want to test. If you want to use the printer to log error messages, leave it connected to the computer.

.....

NOTE: If a problem only occurs when an external device is connected to the computer, the problem could be with the external device or its cable. Isolate the problem by running POST with and without the external device connected.

10. Use Advanced Diagnostics and loopback plugs in the serial and parallel connectors if you plan to test these ports. You may run Advanced Diagnostics from the hard drive or from a diskette.

If you are running Diagnostics from the hard drive, complete the following steps:

- a. Turn on or restart the computer.
- b. Press **F10** when the cursor appears in the upper right corner of the screen. If you do not press **F10** in time, restart the computer and try again. The Welcome screen appears.

If you are running Diagnostics from a diskette, complete the following steps:

- a. Insert the Diagnostics diskette into the diskette drive and turn on the computer.
- b. At the Welcome Screen, press **Enter** to accept **OK**.
- c. Select Computer Checkup (TEST).
- d. Select Prompted Diagnostics after "Identifying System Hardware" completes.
- e. Select Interactive Testing and follow the displayed instructions.

Refer to Chapter 4 for the description and spare part number of the loopback plugs.

After completing the preliminary steps, run POST (Section 3.3) and Computer Checkup (Section 3.5).

3.2 Clearing the Power-On and Setup Passwords

The power-on password prevents use of the computer until the password is entered. The setup password prevents unauthorized changes to Computer Setup. To clear the passwords, you must remove all power from the system board. If you do not know the passwords, use the following procedure to clear the password:

1. Remove all battery packs from the battery bay and DualBay, if applicable.
2. Disconnect the AC power.
3. Remove the real time clock battery.
4. Wait five minutes.
5. Reconnect the AC power.
6. Restart the computer. During the Power-On Self Test (POST), a "162 System Options not Set" message appears. (See Section 3.4 for additional POST error messages).
7. Shut down the computer, then turn off the power again.

-
8. Replace the real time clock battery.
 9. Install the battery pack(s).
 10. Proceed with the troubleshooting procedures.

3.3 Power-On Self Test (POST)

The Power-On Self-Test (POST) is a series of tests that run every time the computer is turned on. POST verifies that the system is configured and functioning properly

To run POST, complete the following steps:

1. Complete the preliminary steps. (Section 2.1).
2. Turn on the computer.

If POST does not detect any errors, the computer beeps once or twice to indicate that POST has run successfully and boots from the hard drive or from a bootable diskette if one is installed in the diskette drive.

3.4 POST Error Messages

This section contains typical error messages that may occur during the power-on self-test (POST).

If you receive an error message read the description and follow the recommended action or run Computer Checkup from the Diagnostics diskette. Information about running Computer Checkup is presented later in this chapter.

If POST detects an error, one of the following events occurs:

- A message with the prefix "WARNING" appears informing you where the error occurred. The system pauses until you press **F1** to continue.
- A message with the prefix "FATAL" appears informing you where the error occurred. After the message, the system emits a series of audible beeps. The system then stops.
- The system emits a series of audible beeps. The system then stops.

Warning messages indicate a potential problem exists such as a system configuration error. When **F1** is pressed, the system should resume. You should be able to correct problems that produce WARNING messages.

IMPORTANT: When a WARNING message includes the prompt to "RUN SCU," run Computer Setup. (Computer Setup replaces the SCU utility.)

Fatal errors emit a beep and may display a FATAL message. Fatal errors indicate severe problems, such as a hardware failure. Fatal errors do not allow the system to resume. Some of the fatal error beep codes are listed at the end of this section.

**Table 3-1
Warning Messages**

Message	Description
Clock not ticking correctly	The real-time clock is not ticking. Replace the real time clock
CMOS checksum invalid, run SCU	CMOS RAM information has been corrupted and needs to be reinitialized by running Computer Setup.
CMOS failure, run SCU	CMOS RAM has lost power and needs to be reinitialized by running Computer Setup.
Floppy controller failed	The diskette drive controller failed to respond to the reset command. Power - down the system and check all appropriate connections. If the diskette drive controller continues to fail, you may need to replace the system board.
Floppy disk track 0 failed	The diskette drive cannot read track 0 of the diskette in the drive. Try another diskette. If the problem persists, you may need to replace the diskette drive.
Floppy information invalid, run SCU	The drive parameters stored in CMOS RAM do not match the diskette drives detected in the system. Run Computer Setup.
Hard disk controller error	The hard drive controller failed to respond to the reset command. Check the drive parameters. Power down the system and check all appropriate connections.
Hardware info does not match video card, run SCU	The video adapter type specified in CMOS RAM does not match the installed hardware. Run Computer Setup.
Keyboard controller failure	The keyboard failed the self-test command. Replace the keyboard.
Keyboard failure	The keyboard failed to respond to the RESET ID command. Press F1 .
No interrupts from Timer 0	The periodic timer interrupt is not occurring. Press F1 .
RAM parity error at location xxxx	A RAM parity error occurred at the specified (hex) location. Press F1 .
ROM at xxxx (LENGTH yyyy) with nonzero checksum (zz)	An illegal adapter ROM was located at the specified address. An external adapter (such as a video card) may be causing the conflict. Run Computer Setup.
Time/Date corrupt - run SCU	The time and date stored in the real time clock have been corrupted, possibly by a power loss. Run Computer Setup.
Unexpected amount of memory, run SCU	The amount of memory detected by POST does not match the amount specified in CMOS RAM. Run Computer Setup.
Hard disk xx failure (or error)	A failure or an error occurred when trying to access the hard drive. Press F1 and continue.

Table 3-2
Fatal Error Messages

Message	Description	Beep Code
CMOS RAM test failed	A walking bit test of CMOS RAM location 0E (Hex) - 3F (Hex) failed.	3
DMA controller faulty	A sequential read/write of the transfer count and transfer address registers within the primary and secondary DMA controllers failed.	4
Faulty DMA page registers	A walking bit read/write of the 16 DMA controller page registers starting at location 80 Hex failed.	0
Faulty refresh circuits	A continuous read/write test of port 61h found that bit 4 (Refresh Detect) failed to toggle within an allotted amount of time.	1
Interrupt controller failed	A sequential read/write of various Interrupt Controller registers failed.	5
ROM checksum incorrect	A checksum of the ROM BIOS does not match the byte value at F000:FFFF.	2
RAM error at location xxxx	RAM error occurred during memory test.	None
Parity error at unknown location	Parity error occurred.	None

The following table lists some of the Fatal Error beep codes, along with the beep sequence (short, long, pause) and the meaning of the beeps.

Table 3-3
Fatal Error Beep Codes

Beep Code	Beep Sequence	Explanation	Remedy
0	S-S-S-P-S-S-L-P	The DMA page registers are faulty.	Replace system board.
1	S-S-S-P-S-L-S-P	The refresh circuitry is faulty.	Replace system board.
2	S-S-S-P-S-L-L-P	The ROM checksum is incorrect.	1. Flash the ROM. 2. Replace system board.
3	S-S-S-P-L-S-S-P	The CMOS RAM test failed.	Replace system board.
4	S-S-S-P-L-S-L-P	The DMA controller is faulty.	Replace system board.
5	S-S-S-P-L-L-S-P	The interrupt controller failed.	Replace system board.
6	S-S-S-P-L-L-L-P	The keyboard controller failed.	Replace system board.
7	S-S-L-P-S-S-S-P	Graphics adapter is faulty.	Replace system board.
8	S-S-L-P-S-S-L-P	Internal RAM is faulty.	Replace processor board.

S = Short, L = Long, P = Pause

.....

3.5 Compaq Utilities

Run the Compaq Utilities to view or test system information and installed or connected devices. Run Compaq Utilities from either the computer hard drive or from diskette.

If running Compaq Utilities from a diskette, note the following:

- Use version 10.13c or later.
- You will not be able to make a utilities diskette.
- Use the Computer Setup diskette to run Computer Setup.

The Utilities menu includes the following:

- Computer Setup
- Computer Checkup (TEST)
- View System Information (INSPECT)
- Create Diagnostics diskette (hard drive only)
- Manage Diagnostics Partition (diskette only)

If the problem persists, call for support. Follow these steps to prepare for the support call:

1. Run Computer Checkup and save the device list to a file and print or save the log of errors.
2. Run the View System Information (INSPECT) utility and print or save that information.
3. Have the files or the printed information available when calling for support.

Running Computer Setup

Computer Setup contains a group of utilities that give you an overall picture of the computer's hardware configuration and aid in troubleshooting. Use these utilities to set custom features, such as security options, power conservation levels, and startup preferences.

A computer running Windows 95 automatically recognizes and configures the system for new devices. However, if there is a configuration problem, or you want to view or reset configuration settings, use Computer Setup.

Computer Setup provides two methods to view the computer's configuration - by type or connection. The default method for viewing Computer Setup is by type.

.....

Categories by type include:

- System Features—security, power, boot management
- Communication—ports, modem, other communication devices
- Storage—storage-related devices such as hard drive or diskette
- Input Devices—keyboard, mouse, and other input devices
- Network—Network adapter, or other network-related devices (Available only when docked or when PC Card is installed)
- Audio—sound properties and audio device settings
- Video—monitor video device resources
- Other devices—devices that could not be categorized

Categories by connection include:

- System Features—security, power, boot management
- System Devices—keyboard, mouse, parallel and serial ports
- ISA—ISA bus and related devices
- PCI—PCI bus and connected devices
- PC Card (PCMCIA) —PC Card bus and PC Card devices

Running Computer Checkup (TEST)

Computer Checkup (TEST) determines whether the various computer components and devices are recognized by the system and are functioning properly. You can display, print, or save the information generated by Computer Checkup.

Computer Checkup is installed on the hard drive. If the hard drive is nonfunctional, you can run it from a diskette.

NOTE: It is recommended that you make diskette copies of Computer Checkup and keep them available for future needs. A current copy can be obtained from the Compaq Customer Support Center.

.....

Computer Checkup

To run Computer Checkup from the hard drive, complete the following steps:

1. Close all applications and shut down the computer.
2. Turn off the computer.
3. Turn on the computer.
4. When the cursor moves to the right side of the screen, press **F10**.

A Welcome Screen is displayed that is followed by the Compaq Utilities main menu.

5. From the Compaq Utilities main menu, select Computer Checkup (TEST).

A diagnostics menu is displayed.

6. Select the option to view the device list.

A list of the installed hardware devices is displayed.

NOTE: Computer Checkup does not detect all non-Compaq devices.

7. Verify that Computer Checkup correctly detected the installed devices.

If the list is correct, select OK. The Computer Checkup option menu is displayed again.

If the list is incorrect, verify that the new devices are installed properly.

8. Select one of the following from the diagnostics menu:

- Quick Check Diagnostics. Runs a quick, general test on each device with a minimal number of prompts. If errors occur, they display when the testing is complete. You cannot print or save the error messages.
- Automatic Diagnostics. Runs an unattended, maximum testing of each device with minimal prompts. You can choose how many times to run the tests, to stop on errors, or to print or save a log of errors.
- Prompted Diagnostics. Allows maximum control over testing the devices. You can choose attended or unattended testing, decide to stop on errors, or choose to print or save a log of errors.

9. Follow the instructions on the screen as the devices are tested. When testing is complete, the Diagnostics menu appears.

10. Exit the Diagnostics menu.

NOTE: Exiting the Compaq Utilities menu restarts the computer and saves the changes.

-
11. Look up the Computer Checkup error codes that were displayed by referring to "Computer Checkup (TEST) Error Codes" and take the recommended action.
 12. Rerun POST and Computer Checkup, taking the recommended actions in given order until the problem is solved and no error messages occur.

Computer Checkup (TEST) Error Codes

IMPORTANT: Rerun Computer Checkup each time you complete a recommended action step. If the problem is resolved when POST and Computer Checkup are rerun (i.e., with no error codes) do not perform the remaining recommended action steps.

Computer Checkup (TEST) error codes occur if the system recognizes a problem while running Computer Checkup. These error codes help identify possible defective assemblies. Tables 3-4 through 3-14 list Computer Checkup error codes, a description of the error condition, and the recommended action for resolving the condition. For removal and replacement procedures for the computer, refer to Chapter 7. For removal and replacement procedures for the convenience base, refer to Chapter 8.

NOTE: The error codes in the following tables are listed in an AYE-XX format, where:

A or AA = Number that represents the faulty assembly.

Y = Test or action that failed.

XX = Specific problem.

View System Information (INSPECT)

The View System Information (INSPECT) utility provides information about the computer and installed or connected devices. You can display, print, or save the information.

Follow these steps to run INSPECT from the hard drive:

1. Turn on the external devices that you want to test. Connect the printer if you want to print the information.
2. Turn on or restart the computer.
3. Press **F10** when the prompt appears in the right side of the display. The Compaq Utilities screen appears.
4. Select View System Information (INSPECT) from the Diagnostics menu.
5. Select the item you want to view from the following list:

System	Memory
ROM	Audio
Keyboard	Operating system
System ports	System files
System storage	Windows files
Graphics	Miscellaneous

6. Follow the instructions on the screen to cycle through the screens, to return to the list and choose another item, or to print the information.

3.6 Diagnostic Error Codes

Diagnostic error codes occur if the system recognizes a problem while running the Compaq Diagnostic program. These error codes help identify possibly defective subassemblies.

Tables 3-4 through 3-14 list possible error codes, a description of the error condition, and the action required to resolve the error condition.

IMPORTANT: Retest the system after completing each step. If the problem has been resolved, do not proceed with the remaining steps.

For assistance in the removal and replacement of a particular subassembly, see Chapter 7, "Removal and Replacement Procedures." For removal and replacement procedures for the convenience base, see Chapter 8.

Table 3-4
Processor Test Error Codes

Error Code	Description	Recommended Action
101-xx	CPU test failed	Replace the processor board and retest.
103-xx	Coprocessor or Weitek Error	
103-xx	DMA page registers test failed	Replace the system board and retest.
104-xx	Interrupt controller master test failed	
105-xx	Port 61 error	
106-xx	Keyboard controller self-test failed	
107-xx	CMOS RAM test failed	
108-xx	CMOS interrupt test failed	
109-xx	CMOS clock test failed	
110-xx	Programmable timer load data test failed	
113-xx	Protected mode test failed	
114-01	Speaker test failed	1. Check system configuration. 2. Verify cable connections to speaker. 3. Replace the system board and retest.

Table 3-5
Memory Test Error Codes

Error Code	Description	Recommended Action
200-xx	Memory machine ID test failed	The following steps apply to error codes 200-xx and 203-xx:
203-xx	Memory system ROM checksum failed	1. Flash the system ROM and retest. 2. Replace the system board and retest.
203-xx	Write/Read test failed	The following steps apply to error codes 203-xx through 215-xx:
204-xx	Address test failed	1. Remove the memory board and retest.
211-xx	Random pattern test failed	2. Install a new memory board and retest.
214-xx	Noise test failed	
215-xx	Random address test failed	

Table 3-6
Keyboard Test Error Codes

Error Code	Description	Recommended Action
300-xx	Failed ID Test	The following steps apply to error codes 300-xx through 304-xx :
301-xx	Failed Selftest/Interface Test	1. Check the keyboard connection. If disconnected, turn off the computer and connect the keyboard.
303-xx	Failed Individual Key Test	2. Replace the keyboard and retest.
304-xx	Failed Keyboard Repeat Test	3. Replace the system board and retest.

Table 3-7
Parallel Printer Test Error Codes

Error Code	Description	Recommended Action
401-xx	Printer failed or not connected	The following steps apply to error codes 401-xx through 403-xx :
402-xx	Failed Port Test	1. Connect the printer.
403-xx	Printer pattern test failed	2. Check power to the printer. 3. Install the loop-back connector and retest. 4. Check port and IRQ configuration. 5. Replace the system board and retest.

**Table 3-8
Diskette Drive Test**

Error Code	Description	Recommended Action	
600-xx	Diskette ID drive types test failed	The following steps apply to error codes 600-xx through 698-xx: 1. Replace the diskette media and retest. 2. Check and/or replace the diskette power and signal cables and retest. 3. Replace the diskette drive and retest. 4. Replace the system board and retest.	
601-xx	Diskette format failed		
602-xx	Diskette read test failed		
603-xx	Diskette write, read, compare test failed		
604-xx	Diskette random read test failed		
605-xx	Diskette ID media failed		
606-xx	Diskette speed test failed		
609-xx	Diskette reset controller test failed		
610-xx	Diskette change line test failed		
697-xx	Diskette type error		
698-xx	Diskette drive speed not within limits		
699-xx	Diskette drive/media ID error		Run Computer Setup.

**Table 3-9
Serial Test Error Codes**

Error Code	Description	Recommended Action
1101-xx	Serial port test failed	1. Check port configuration. 2. Replace the system board and retest.

**Table 3-10
Hard Drive Test Error Codes**

Error Code	Description	Recommended Action
1701-xx	Hard drive format test failed	The following steps apply to error codes 1701-xx through 1736-xx : 1. Run Computer Setup. 2. Replace the hard drive and retest. 3. Replace the system board and retest.
1702-xx	Hard drive read test failed	
1703-xx	Hard drive write/read/compare test failed	
1704-xx	Hard drive random seek test failed	
1705-xx	Hard drive controller test failed	
1706-xx	Hard drive ready test failed	
1707-xx	Hard drive recalibration test failed	
1708-xx	Hard drive format bad track test failed	
1709-xx	Hard drive reset controller test failed	
1710-xx	Hard drive park head test failed	
1715-xx	Hard drive head select test failed	
1716-xx	Hard drive conditional format test failed	
1717-xx	Hard drive ECC* test failed	
1719-xx	Hard drive power mode test failed	
1724-xx	Network preparation test failed	
1736-xx	Drive monitoring test failed	

* ECC = Error Correction Code

Table 3-11
Video Test Error Codes

Error Code	Description	Recommended Action
501-xx	Video controller test failed	The following apply to error codes 501-xx through 516-xx: 1. Connect an external monitor and retest. 2. Replace the LED status board and retest. 3. Replace the display and retest. 4. Replace the system board and retest.
502-xx	Video memory test failed	
503-xx	Video attribute test failed	
504-xx	Video character set test failed	
505-xx	Video 80 × 25 mode 9 × 14 character cell test failed	
506-xx	Video 80 × 25 mode 8 × 8 character cell test failed	
507-xx	Video 40 × 25 mode test failed	
508-xx	Video 320 × 200 mode color set 0 test failed	
509-xx	Video 320 × 200 mode color set 1 test failed	
510-xx	Video 640 × 200 mode test failed	
511-xx	Video screen memory page test failed	
513-xx	Video gray scale test failed	
514-xx	Video white screen test failed	
516-xx	Video noise pattern test failed	
2403-xx	Video memory test failed	
2403-xx	Video attribute test failed	
2404-xx	Video character set test failed	
2405-xx	Video 80 × 25 mode 9 × 14 character cell test failed	
2406-xx	Video 80 × 25 mode 8 × 8 character cell test failed	
2408-xx		
2409-xx	Video 320 × 200 mode color set 1 test failed	
2410-xx	Video 640 × 200 mode test failed	
2411-xx	Video screen memory page test failed	
2413-xx	Video gray scale test failed	
2414-xx	Video white screen test failed	
2416-xx	Video noise pattern test failed	
2418-xx	ECG/VGC memory test failed	

Table 3-11 *Continued*

Error Code	Description	Recommended Action
2419-xx	ECG/VGC ROM checksum test failed	The following steps apply to error codes 2403-xx through 2456-xx:
2421-xx	ECG/VGC 640 × 200 graphics mode test failed	1. Run Computer Setup.
2423-xx	ECG/VGC 640 × 350 16 color set test failed	2. Disconnect external monitor and test with internal LCD display.
2423-xx	ECG/VGC 640 × 350 64 color set test failed	3. Replace the display assembly and retest.
2424-xx	ECG/VGC monochrome text mode test failed	4. Replace the system board and retest.
2425-xx	ECG/VGC monochrome graphics mode test failed	
2431-xx	640 × 480 graphics test failure	
2433-xx	320 × 200 graphics (256 color mode) test failure	
2448-xx	Advanced VGA Controller test failed	
2451-xx	133-column Advanced VGA test failed	
2456-xx	Advanced VGA 256 Color test failed	
2458-xx	Advanced VGA BitBLT test	The following applies to error codes 2458-xx through 2480-xx:
2468-xx	Advanced VGA DAC test	Replace the system board and retest.
2477-xx	Advanced VGA data path test	
2478-xx	Advanced VGA BitBLT test	
2480-xx	Advanced VGA Linedraw test	

Table 3-12
Audio Test Error Codes

Error Code	Description	Recommended Action
3206-xx	Audio System Internal Error	Replace the audio board and retest.

Table 3-13
Pointing Device Interface Test Error Codes

Error Code	Description	Recommended Action
8601-xx	Mouse test failed	The following steps apply to 8601-xx and 8603-xx: 1. Replace the top cover assembly.
8603-xx	Interface test failed	2. Replace the system board and retest.

Table 3-14
CD-ROM Test Error Codes

Error Code	Description	Recommended Action
3301-xx	CD-ROM drive read test failed	The following steps apply to error codes 3301-xx through 3305-xx and 6600-xx through 6623-xx:
3305-xx	CD-ROM drive seek test failed	1. Replace the CD and retest.
6600-xx	ID test failed	2. Replace the CD-ROM drive and retest.
6605-xx	Read test failed	3. Replace the system board and retest.
6608-xx	Controller test failed	
6623-xx	Random read test failed	

3.7 Troubleshooting Without Diagnostics

This section provides information about how to identify and correct some common hardware, memory, and software problems. It also explains several types of common messages that may be displayed on the screen. The following pages contain troubleshooting information on:

- Audio
- Battery/Battery gauge
- Diskette/Diskette drive
- Hard drive
- CD-ROM drive
- Hardware installation
- Infrared connection
- Keyboard (Numeric keypad)
- Pointing device
- Memory
- PC Card
- Power
- Printer
- Screen (LCD and CRT)
- Software

3.7.1 Solving Minor Problems

Some minor problems and possible solutions are outlined in the following tables. If the problem appears related to a software application, check the documentation provided with the software.

Solving Audio Problems

Some common audio problems and solutions are listed in the following table.

Problem	Probable Cause	Solution(s)
Computer beeps once after you turn it on.	This is typical; it indicates successful completion of the Power-On Self-Test (POST).	No action is required.
Computer does not beep after the Power-On Self-Test (POST).	Speaker volume is off or has been turned down.	If the speaker icon is not displayed on the display, press Fn+F5 to adjust the volume.
	Beeps have been turned off.	Run Computer Setup and turn on beeps.

Solving Battery and Battery Gauge Problems

Some common causes and solutions for battery problems are listed in the following table. The "Solving Power Problems" section in this chapter also may be applicable.

Table 3-16
Solving Battery and Battery Gauge Problems

Problem	Probable Cause	Solution(s)
Computer won't turn on when battery pack is inserted and power cord is unplugged.	Battery is discharged.	Connect the computer to an external power source and charge the battery pack.
		Replace the battery pack with a fully charged battery pack.
		Check the battery connectors on the system board to verify they are evenly spaced and that they are not bent or broken.
Computer is beeping and battery light is blinking.	Battery charge is low.	Immediately save any open file(s). Then do any one of the following: <ul style="list-style-type: none"> ■ Connect the computer to an external power source to charge the battery pack. ■ Initiate Suspend and replace the battery pack with a fully charged battery pack. ■ Turn the computer off or initiate Hibernation until you can find another power source or charge the battery pack.
Computer battery light blinks to indicate low- battery condition, but computer does not beep.	Low - battery beeps were turned off.	Run Computer Setup to turn on the low - battery warning beeps.
	Volume is turned off or turned down too low.	Press Fn+F5 to turn the speaker on and then adjust the volume.
Battery light doesn't light and battery pack won't fast charge.	Battery pack is already charged.	No action is necessary.
	Battery pack was exposed to temperature extremes.	Allow time for the battery pack to return to room temperature.
	Battery pack is at end of its life.	Replace battery pack.
Computer turned off and information in memory was lost when replacing the battery pack.	The battery pack was not replaced.	Turn off the computer and restart.

Continued

Table 3-16 *Continued*

Problem	Probable Cause	Solution(s)
Battery charge does not last as long as expected.	Battery is being exposed to high temperatures or extremely cold temperatures.	Keep the battery pack within the recommended temperature ranges. Operating: 50°F to 104°F (10°C to 40°C) Storage: -4°F to 86°F (-20°C to 30°C) Recharge the battery pack.
	Battery has partially self-discharged.	Recharge the battery. Discharge the battery completely and then recharge it.
	Power management is disabled.	Set a power management level in Computer Setup.
	An external device or PC Card is draining the battery.	Turn off or disconnect external devices when not using them.
Battery pack is warm to the touch after charging.	Normal warming has occurred due to charging.	No action is required.
Battery gauge is inaccurate.	The battery pack is new or has not been used for a long period.	Fully charge the battery pack until the battery light on the computer turns off. Condition the battery pack by fully charging, then fully discharging, and then fully recharging. If condition persists, replace the battery. If the battery gauge is still inaccurate, replace the system board.
Battery pack operating time is far less than the documented average operating time.	Power management is turned off or disabled.	Enable power management in Computer Setup and in Windows Power Properties. The power management icon should be visible on the status panel.
	An external device or PC Card is draining the battery.	Turn off or disconnect external devices when not using them.
	Battery pack has partially self-discharged.	To maintain the charge, leave battery packs in the computer when it is connected to external power. If the computer is disconnected from external power for more than two weeks, remove battery packs from the computer to reduce the discharge rate.
	Fuel gauge is inaccurate.	Use the low battery warning beeps to determine the low battery condition.
	Battery pack is being drained by high power-use accessory.	Reduce use of accessories which drain power such as the CD-ROM drive or PC Card.
	Battery pack is being exposed to high temperatures or extremely cold temperatures.	Keep the battery pack within the recommended temperature ranges: Operating: 50°F to 104°F (10°C to 40°C) Storage: -4°F to 86°F (-20°C to 30°C). Recharge the battery pack.

Solving Diskette and Diskette Drive Problems

Some common causes and solutions for diskette and diskette drive problems are listed in the following table.

Table 3-17
Solving Diskette and Diskette Drive Problems

Problem	Probable Cause	Solution(s)
Diskette drive light does not turn on.	Diskette drive is not installed properly.	Remove the diskette drive and install it properly.
Diskette drive light stays on.	Diskette is damaged.	Run SCANDISK on the diskette. At the system prompt, enter SCANDISK A:
	Diskette is incorrectly inserted.	Remove diskette and reinsert.
	Software program is damaged.	Check the program diskettes.
Diskette drive cannot write to a diskette.	Diskette is write-protected.	Disable the diskette's write-protect feature or use a diskette that is not write-protected.
	Computer is writing to the wrong drive.	Check the drive letter in the path statement.
	Not enough space is left on the diskette.	Use another diskette.
	Drive error has occurred.	Run Computer Checkup from the Compaq Diagnostics diskette.
	Diskette is not formatted.	Format the diskette. At the system prompt, enter FORMAT A:
Diskette drive cannot read a diskette.	The wrong type of diskette is being used.	Use the type of diskette required by the drive.
	Diskette has a bad sector.	Copy files to hard drive or another diskette. Reformat bad floppy.
	Drive error has occurred.	Run Computer Checkup from the Compaq Diagnostics diskette.
	Diskette is not formatted.	Format the diskette. At the system prompt, enter FORMAT A:
Cannot boot from diskette.	Bootable diskette is not in drive A.	Put the bootable diskette in drive A. If a diskette drive is in the computer DualBay, that is drive A.
	Diskette Boot is disabled in Computer Setup.	Run Computer Setup and enable Diskette Boot from the Boot Management menu.

Solving Hard Drive Problems

Some common causes and solutions for hard drive problems are listed in the following table.

Problem	Probable Cause	Solution(s)
Reading hard drive takes an unusually long time after restarting the computer.	System entered Hibernation due to low-battery condition and is now exiting from it.	Give the system time to restore the previously saved data to its exact state before Hibernation.
Hard drive error occurs.	Hard drive has bad sectors or has failed.	Run Computer Checkup. See POST error messages.
Hard drive does not work.	Hard drive is not seated properly.	Turn off the computer, remove and reinsert the hard drive, then turn the computer on.
	Hard drive is damaged.	Replace the hard drive.

Solving CD-ROM Drive Problems

Some common causes and solutions for CD-ROM drive problems are listed in the following table.

Problem	Probable Cause	Solution(s)
CD-ROM drive cannot read a compact disc.	Compact disc is upside down or is improperly inserted in the CD-ROM drive.	Open the CD loading tray, lay the compact disc in it (label side up), then close the tray.
CD-ROM drive does not work.	CD-ROM drive is not seated properly.	Shut down the computer, remove and reinsert the drive, then turn on the computer.
	CD-ROM drive was inserted while the computer was on, in Suspend, or in Hibernation.	Shut down computer; then turn it on again. The drive is initialized during power up.

Solving Hardware Installation Problems

Some common causes and solutions for hardware installation problems are listed in the following table.

Table 3-20
Solving Hardware Installation Problems

Problem	Probable Cause	Solutions(s)
A new device is not recognized as part of the computer system.	Cable(s) of new external device are loose or power cables are unplugged.	Ensure that all cables are properly and securely connected.
	Power switch of new external device is not turned on.	Turn off the computer, turn on the external device, then turn on the computer to integrate the device with the computer system.
	Device is not seated properly.	Turn off the computer and reinsert the device.

Solving Infrared Connection Problems

Some common causes and solutions for infrared connection problems are listed in the following table.

Table 3-21
Solving Infrared Connection Problems

Problem	Cause	Solution(s)
Cannot link with another computer.	Interrupt request (IRQ) conflict.	Check IRQ assignments for conflicts and reassign as necessary.
	Baud rate conflict.	Select the same baud rate for both computers.
Data transmission problem.	Direct sunlight, fluorescent light, or flashing incandescent light is close to the infrared connections.	Remove the interfering light sources.
	Interference from other wireless devices.	Keep remote control units such as wireless headphones and other audio devices away from the infrared connections
	Physical obstruction.	Do not place objects between the two units that will interfere with a line-of-sight data transmission.
	Movement.	Do not move either unit during data transmission.
	Orientation.	Adjust devices so that they point within 30 degrees of each other.
	Distance.	Verify that devices are not more than 3 feet (1 m) apart.

Solving Keyboard/Numeric Keypad Problems

Some common causes and solutions for keyboard/numeric keypad problems are listed in the following table.

Problem	Probable Cause	Solution(s)
Embedded numeric keypad on computer keyboard is disabled.	Num Lock function is not enabled.	Press the Fn+NumLk keys to enable the Num Lock function and embedded numeric keypad. The Num Lock icon on the status panel turns on.
Keyboard is locked.	QuickLock initiated.	Enter the password to exit QuickLock.

Solving Pointing Device Problems

Some common causes and solutions for pointing device problems are listed in the following table.

Problem	Cause	Solution(s)
External pointing device does not work.	Incorrect device driver or no device driver is installed.	Install the device driver.
	The device driver is not installed in Windows.	Install the device driver in Windows.
Integrated pointing device does not work.	An external pointing device is connected and the system has disabled the internal pointing device.	Initiate Suspend and disconnect the external pointing device.

Solving Memory Problems

Some common causes and solutions for memory problems are listed in the following table.

Problem	Probable Cause	Solution(s)
Memory count during Power-On Self-Test (POST) is incorrect.	Optional memory expansion board is installed incorrectly, is incompatible with the computer, or is defective.	Ensure that the optional memory expansion board is installed correctly.
"Out of Memory" message is displayed on the screen or insufficient memory error occurs during operation.	System ran out of memory for the application.	Check the application documentation for memory requirements. Install additional memory.
	Too many TSR (terminate and stay resident) applications are running.	Remove from memory any TSR applications that you do not need.

Solving PC Card Problems

Some common causes and solutions for PC Card problems are listed in the following table.

Table 3-25
Solving PC Card Problems

Problem	Probable Cause	Solution(s)
PC Card error messages appear when the computer is turned on.	The PC Card slot is disabled.	Run Computer Setup and enable the PC Card slots on the Security Menu.
Computer does not beep when PC Card is inserted but PC Card works correctly	System beeps are turned down.	Press Fn+F5, then press the right arrow key to increase the system beeps volume.
When turned on, the computer does not beep when a PC Card is inserted.	Card is not inserted properly	In Windows 95, double-click PC Card icon, click the Global Settings tab. Deselect Disable PC Card Sound Effects.
	PC Card beeps are disabled.	
	Speaker is turned off or volume is turned down.	Increase the volume.
	PC Card drivers are not installed.	Double-click the Add New Hardware icon in the Control Panel for installation instructions.
	The PC Card slots are disabled.	Run Computer Setup and then select the Security menu to enable PC Card slots.
The PC Card drivers (Socket Services, Card Services, Card ID) fail with error messages when the computer is turned on.	Card or card driver is not supported.	Check the list of PC Cards tested successfully in Compaq PC Card platforms.
	The PC Card slot is disabled.	Run Computer Setup and select the Security menu to enable PC Card slots.
	PC Card modem, fax, or network card does not work.	
PC Card modem, fax, or network card does not work.	Card is not fully inserted into the slot or is not inserted properly.	Ensure the card is inserted in the correct orientation.
	Telephone cord is not plugged in all the way.	Check and secure telephone connection.
	Necessary drivers are not installed (turned on).	Install drivers.

Continued

Table 3-25 *Continued*

Problem	Probable Cause	Solution(s)
PC Card modem or fax card does not work.	You are trying to access the card using the wrong COM port.	See Chapter 9 to verify COM port.
	The card conflicts with a serial device.	See Chapter 9 to verify address.
	The card is not supported.	Use supported cards only.
Modem network PC Card does not work.	Network driver is not installed or is not set up properly.	Install driver.
	Telephone cord is not properly connected.	Verify telephone connection.
Memory or storage card does not work.	SRAM and flash memory cards require the memory card driver to be loaded (turned on).	Install driver.
	Flash memory cards require the Microsoft FlashFile System to be loaded.	
	Hard drives on flash mass storage cards require the PC Card ATA driver to be loaded.	
	You are trying to access the hard drive card using the wrong drive letter.	Double-click My Computer to verify the drive letter assigned to the card.
	The card is not supported.	Check the list of PC Card cards tested successfully in Compaq PC Card platforms.

Solving Power Problems

Also see "Solving Battery and Battery Gauge Problems" in this chapter.

Table 3-26
Solving Power Problems

Problem	Probable Cause	Solution(s)
Computer won't turn on and LEDs aren't lit.	Computer is not connected to a power source.	Insert battery or connect an external power source.
	Power cords to the external power source are unplugged.	Ensure that power cords connecting the computer and the external power source are plugged in properly.
	DC-DC Converter is defective.	Replace the DC-DC power board.
	Integrated AC Power is defective.	Replace the integrated AC Power and restart.
Computer turned off while it was left unattended and the power /suspend light is off.	System initiated Hibernation due to a critical low-battery condition.	Replace the battery pack with a fully charged battery pack or connect the computer to an external power source. Then turn on the computer.
	System initiated Hibernation after a preset timeout.	Turn on the computer. NOTE: To change the Hibernation setting in Windows 95, click the Hibernation tab in Power properties. Windows NT, run Computer Setup and select Power Management.
Computer initiated Suspend automatically or turned off automatically when it was docked in expansion base.	The unit temperature was exceeded.	Computer is in an exceedingly hot environment. Let the computer cool down. Make sure the ventilation intake and exhaust are not obstructed.

Solving Printer Problems

If you experience problems printing, run a printer self-test. Refer to the documentation provided with the printer for instructions. If the self-test fails, it is a printer-specific problem. Also refer to the printing section of the application documentation.

Table 3-27
Solving Printer Problems

Problem	Probable Cause	Solution(s)
Printer will not turn on.	The signal cable may not be connected properly, or the printer is unplugged.	Ensure that the signal cable is properly connected and that the power cord is connected to the electrical outlet.
Printer will not print.	Printer is not turned on or is off line.	Turn the printer on and set it to on-line.
	The device drivers for the application are not installed.	Refer to the printer documentation to install the correct printer driver.
	Printer that is set up for a network is not connected to the network.	Connect the printer to the network.
	Printer cable is too long, unshielded, or defective.	Replace the cable.
	Paper tray is empty.	Fill the paper tray with paper and set the printer to on-line.
Printer prints garbled information.	Correct printer drivers are not installed.	Refer to the printer documentation to install the correct printer driver.
	Cable is not connected properly.	Ensure that the printer signal cable is properly connected to the computer.
	Cable is defective.	Replace the printer cable and retest.

Solving Screen Problems

This section lists some common causes and solutions for computer display and external monitor problems.

You can perform a monitor self-test on an external VGA color or monochrome monitor by disconnecting the monitor from the computer. To do so, complete the following steps:

1. Turn off the monitor.
2. Turn off the computer.
3. Disconnect the monitor signal cable from the computer.
4. Turn on the monitor and allow it to warm up for one minute.

The screen should be white. A narrow black border may also appear on the left and right sides of the display. Either of these displays indicates that the monitor is working properly.

Table 3-28
Solving Screen Problems

Problem	Probable Cause	Solution(s)
Characters are dim.	The brightness or contrast (if applicable) control is not set properly.	Adjust the control(s) using Fn+F9 (contrast) and Fn+F10 (brightness).
	Computer screen is in direct light.	Tilt the display or move computer.
	Display is damaged.	Replace the display.
Screen is blank.	You initiated QuickLock/QuickBlank.	Enter the password to exit QuickLock/QuickBlank.
	You may have another screen - blanking utility installed.	Press any key and/or enter the password.
	Screen save was initiated after the Power Management timeout period of inactivity	Press any key or click the mouse.
	If an STN screen is used, brightness/contrast needs adjusting.	Use the hotkeys to adjust the brightness/contrast.
	Screen has overheated	If the computer is in direct sunlight, move it and allow it to cool.
	Suspend was initiated.	Press the suspend button to exit Suspend.
Computer screen is blank and the screen on an external monitor displays information.	Display was switched to the external monitor.	Press the Fn+F4 hotkey to display information on the computer screen.
Screen is blank and the power/suspend light is blinking	System is in Suspend	Press the Suspend button to exit Suspend. Enter the power-on password if prompted.
Screen is blank, the power/suspend light is blinking, and the battery light is blinking	System has entered a low-battery condition	Immediately connect the computer to an external power source or replace the battery pack.
External monitor does not display information	External monitor was connected after the computer was turned on	Press the Fn+F4 hotkey to switch to the external monitor
	The external monitor signal cable or power cord is not properly connected.	Verify the cables are properly connected.
Distorted or garbled characters on the screen are mixed with text.	The <i>ANSI.SYS</i> driver is not in the <i>CONFIG.SYS</i> file or the path is incorrect.	Add the <i>ANSI.SYS</i> driver to the <i>CONFIG.SYS</i> file. Add the following line: <code>DEVICE=C:\ANSI.SYS</code>
Garbled characters on internal display or flashing internal display when connected to external monitor.	You are using 800 × 600 or higher resolution on external display and have toggled back to internal display, which only supports 640 × 480 resolution.	Restart the computer. If simultaneous display is desired, use 640 × 480 resolution.
The image on the external monitor does not fill the screen.	You are using an external monitor and simultaneously displaying an image on the computer display.	This is typical; no action is required.
Small red, green, or blue spots appear on the computer TFT display.	Small spots, called on-pixels, often appear on TFT screens. Compaq limits the number of these on-pixels to 0.003% of the approximately 1 million transistors that are on a 12.1-, or 11.3-inch display.	This is typical; no action is required.
When in MS-DOS mode, the image on the computer display does not fill the screen. When displaying simultaneously, the image on the external monitor may not be centered.	To maintain a high-quality image, the 800 × 600 models do not stretch the lower-resolution image of MS-DOS mode to fill the screen.	This is typical; no action is required.

Solving Software Application Problems

Most software application or installation problems occur as a result of one or more of the following:

- The application was not installed correctly.
- Memory was not allocated correctly.
- A conflict exists between applications.

Table 3-29
Solving Software Application Problems

Problem	Probable Cause	Solution(s)
Cannot use an application.	The application has not been added to the PATH statement.	Run the program with the full path name.
Insufficient memory to run application.	System ran out of memory for the application.	Check the application documentation for memory requirements. Install additional memory.
	Too many TSR (terminate and stay resident) applications are running.	Remove from memory any TSR applications that you do not need.
	Application requires Windows to be run in enhanced mode.	Exit Windows and enter again using the following command to run in enhanced mode: WIN/3

Solving Convenience Base Problems

Table 3-30
Display Problems and Solutions

Problem	Possible Cause	Solution(s)
Garbled characters on internal display or flashing internal display when connected to external monitor.	Toggled to internal monitor from an external monitor that is using higher resolution than that supported by the computer.	Restart the system. If simultaneous display is desired, use the resolution supported by the computer.
External monitor display is distorted.	Energy Star Monitor is selected on the Power Management menu, and the external monitor is not Energy Star compliant.	Press any key or move the mouse to restore the display. If the display remains distorted, turn the monitor off and then back on. Deselect the Energy Star Monitor setting.
Computer screen and external monitor do not display information simultaneously.	Display was switched using the hotkeys.	Press the Fn+F4 hotkeys to toggle through the three display possibilities.
	External monitor was not turned on before the system was turned on.	Initiate Suspend, turn on external monitor, then exit Suspend to integrate new monitor.
	External monitor was connected after the computer was turned on.	Initiate Suspend, connect external monitor, turn on the monitor, then exit Suspend.

Table 3-31
Docking Problems and Solutions

Problem	Possible Cause	Solution(s)
The computer is not properly docked in the convenience base.	The computer is not properly centered over docking latch.	Slide computer forward from convenience base. Center over docking latch and replace. Push docking lever back to dock.
	The computer is not coupled to docking connector.	Pull docking lever forward to release computer and re-dock.

Table 3-32
Undocking Problems and Solutions

Problem	Possible Cause	Solution(s)
The computer will not undock.	Connectors are tight.	Grasp the computer with one hand and pull forward while pulling forward on docking lever with other hand.
	Security cable is locked.	Unlock security cable.
	PC Card cable is attached to the computer.	Remove cable from PC Cards before undocking.
	The docking lever in the convenience base may be defective.	Replace the Convenience Base.

Table 3-33
External Device Installation Problems and Solutions

Problem	Possible Cause	Solution(s)
A new device is not recognized as part of the computer system.	Power switch of the new external device was not turned on before the system was turned on.	Initiate Suspend, turn on external devices with power switches, then exit Suspend to integrate the new device.
	External device was connected after system was turned on.	Windows 95: Initiate Suspend, plug in and turn on external devices with power switches, then exit Suspend to integrate the new device. Windows NT: Power off computer and external devices. Power back on to integrate new device.
	The signal cable or power cord of the new device is loose or disconnected.	Ensure that all cables are properly and securely connected. Ensure that all power cords are properly and securely plugged into an electrical outlet.
	The signal cable or power cord of the new device may be defective.	Try connecting a different signal cable and/or power cord.

Table 3-34
Keyboard Problems and Solutions

Problem	Possible Cause	Solution(s)
External keyboard does not work.	External keyboard may not be securely connected or may be connected to an incorrect external connector.	Ensure that the external keyboard is properly and securely connected to the external keyboard connector.

Table 3-35
Mouse Problems and Solutions

Problem	Possible Cause	Solution(s)
External mouse does not work.	External mouse may not be securely connected or may be connected to an incorrect external connector.	Ensure that the external mouse is securely connected to the mouse connector or the correct external connector.
	Mouse was connected after system was turned on.	Turn off the unit, connect the mouse, then turn the unit on to integrate the mouse.

Solving Network Problems

This section provides guidelines for troubleshooting common Ethernet network problems. Refer to these guidelines when you have determined that the computer in the convenience base is not communicating with the network. These guidelines do not discuss the process of debugging the network cabling.

These are common problems to check first. Refer to the tables on the following pages for additional problems and solutions.

- Ensure that the cabling is securely attached to the convenience base. A loose cable is the most common cause of network problems. If the cable is loose, secure it and see if the computer can communicate with the network.
- Determine whether the current computer or another computer has communicated with the network from the convenience base. If so, determine whether anything was added or changed that could have stopped the network interface from working.
- Run Diagnostics before installing the network drivers to verify that the network interface is working correctly.

Table 3-36
Solving Ethernet Network Problems

Problem	Possible Cause	Solution(s)
When turned on, the computer does not detect the network.	The computer is not connected to the Ethernet network.	Connect the computer to the Ethernet network.
	Suspend or Hibernation was initiated.	Exit Suspend or Hibernation. Windows 95: Restart the computer by clicking Start, Shut Down, Restart the Computer. Windows NT: Click Start, Shut Down. Power the computer back on.
After installing network operating system, computer does not detect network interface.	The network driver fails to load during system initialization.	Ensure that network drivers are loaded and that the drive path is correct.
	If using a network interface card connected to a parallel port, the port has been disabled.	Enable the parallel port. Restart the computer. Press F10 immediately when the cursor moves to the top right side of the screen.
Diagnostics reports a failure.	Suspend or Hibernation was initiated.	Exit Suspend or Hibernation. Windows 95: Restart the computer by clicking Start, Shut Down, Restart the Computer. Windows NT: Click Start, Shut Down. Power computer back on.
	The cable is not securely connected to the network connector on the Ethernet network.	Ensure that the cable is securely connected to the proper network connector on the Ethernet network.
	There is a problem with the cable or a device at the other end of the cable.	Ensure that the cable and device at the other end of the network connection are operating properly.
	Possible hardware failure.	Replace the Convenience Base.

Solving Ethernet Network Problems *Continued*

Problem	Possible Cause	Solution(s)
Diagnostics reports no errors, but the computer does not communicate with the network.	Network drivers are not loaded.	Load the network drivers. Windows 95: Restart the computer by clicking Start, Shut Down, Restart the Computer. Windows NT: Click Start, Shut Down. Power the computer back on.
	A network configuration error may have occurred (i.e., *.ini, *.inf, *.nif, or CONFIG.SYS files may need to be modified).	Contact the network administrator.
The computer stopped communicating with the network after exiting Suspend.	Suspend or Hibernation was initiated.	Exit Suspend or Hibernation. Windows 95: Restart the computer by clicking Start, Shut Down, Restart the Computer. Windows NT: Click Start, Shut Down. Power computer back on.
	The computer does not detect network drivers.	Windows 95: Restart the computer by clicking Start, Shut Down, Restart the Computer. Windows NT: Click Start, Shut Down. Power computer back on.
The computer stopped communicating with the network for no apparent reason.	The cable is not securely connected to the network connector on the Ethernet.	Ensure that the cable is securely connected to the convenience base and Ethernet network.
	General network failure.	Ensure that the network you are connected to is running and has not experienced problems that would prevent the connection.
	The files for the network drivers have been corrupted.	Reinstall the network drivers.

IMPORTANT: If the 100BaseT Ethernet upgrade module has been installed, remove this module before returning the convenience base for replacement.

Illustrated Parts for the Computer

This chapter provides illustrated parts and references for spare parts for the Compaq Armada 1500 Family of Personal Computers. To review an illustrated parts breakdown of the computer, refer to the *Illustrated Parts Map* that comes with this guide.

.....

4.1 System Unit

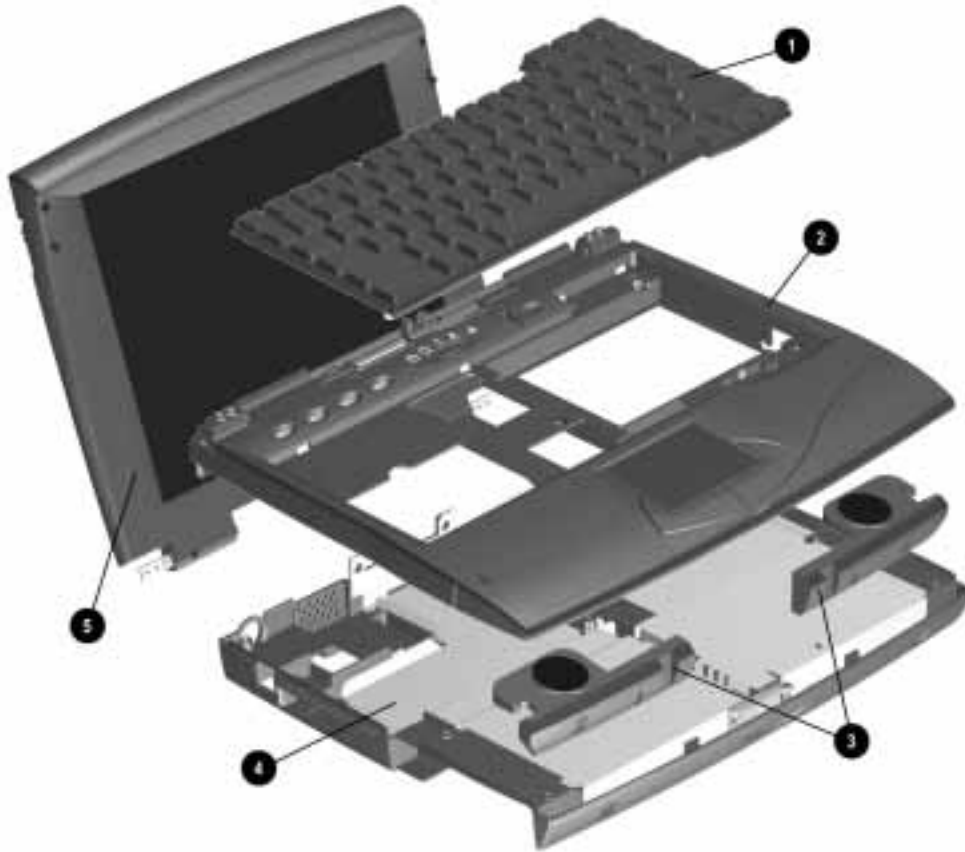

Figure 4-1. System Unit

**Table 4-1
System Unit**

Item	Description	Spares Part Number
*	Keyboard (Belgian)	254968-181
*	Keyboard (Brazilian)	254968-035
*	Keyboard (Danish)	254968-081
*	Keyboard (French)	254968-051
*	Keyboard (French Canadian)	254968-121
*	Keyboard (German)	254968-041
*	Keyboard (Hangeul)	254968-033
*	Keyboard (Italian)	254968-061
*	Keyboard (Japanese)	254968-191
*	Keyboard (Latin American Spanish)	254968-161
*	Keyboard (Norwegian)	254968-091
*	Keyboard (Portuguese)	254968-131
*	Keyboard (Spanish)	254968-071
*	Keyboard (Swedish/Finnish)	254968-101
*	Keyboard (Swiss)	254968-111
*	Keyboard (Taiwanese)	254968-034
*	Keyboard (UK English)	254968-031
1	Keyboard (US/Canada)	254968-001
2	Top cover assembly	254978-001
3	Speakers	254979-001
4	Base enclosure assembly	212535-001
5	11.3-inch CSTN display assembly	254966-001
*	12.1-inch CTFT display assembly	254967-001
* Not illustrated		

.....

4.2 Mass Storage Devices

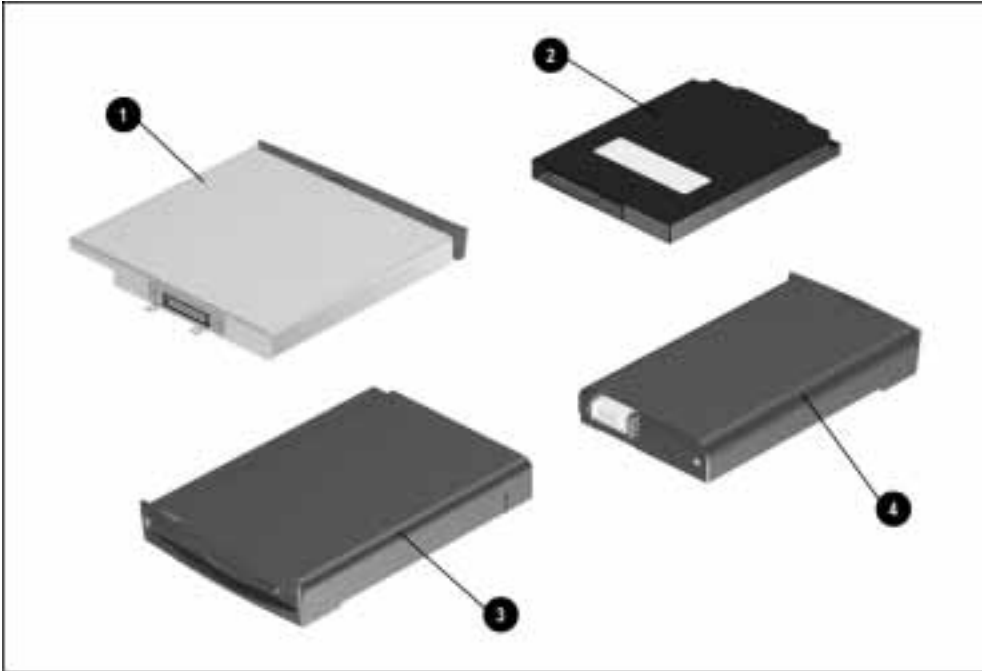

Figure 4-2. Mass Storage Devices



Table 4-2
Mass Storage Devices

Item	Description	Spares Part Number
1	10x CD-ROM Drive	254974-001
2	1.0-GB hard drive	254963-001
*	1.4-GB hard drive	254964-001
3	1.4-MB, diskette drive	254962-001
4	Lithium Ion Battery Pack	254960-001
*	Nickel Metal Hydride Battery Pack	254959-001

* Not illustrated

.....

4.3 Cables and Power Cords

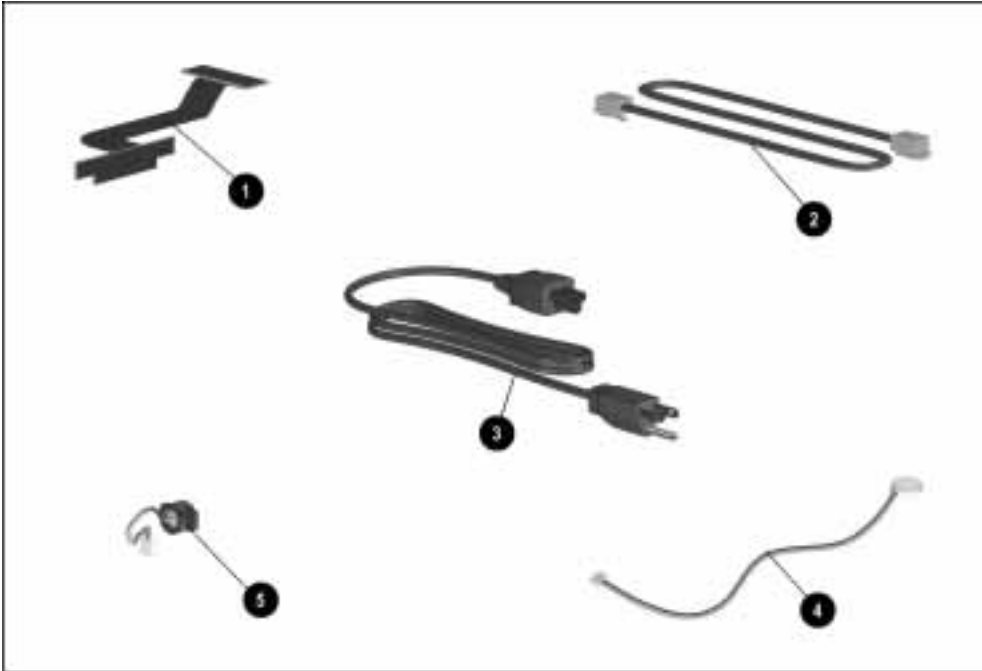

Figure 4-3. Cables and Power Cords



Table 4-3
Cables and Power Cords

Item	Description	Spares Part Number
1	CD-ROM drive cable	254975-001
2	Modem cable	165224-001
3*	AC Power cord (Australia/New Zealand)	246959-011
*	AC Power cord (Denmark)	246959-081
*	AC Power cord (Europe)	246959-021
*	AC Power cord (Italy)	246959-061
*	AC Power cord (Japan)	246959-291
*	AC Power cord (Korea)	246959-AD1
*	AC Power cord (Switzerland)	246959-AG1
*	AC Power cord (UK and Singapore)	246959-031
	AC Power cord (US/Canada)	246959-001
4	RTC Battery	254971-001
5	Microphone (included in Miscellaneous Parts kit)	254981-001

* Not illustrated

.....

4.4 Standard and Optional Boards

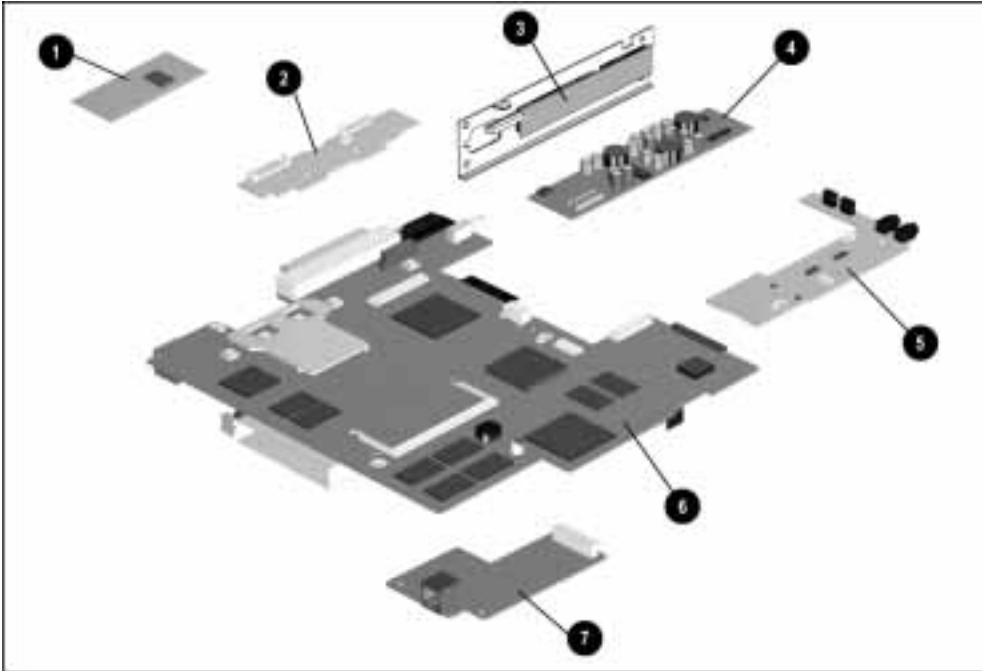

Figure 4-4. Standard and Optional Boards

Table 4-4
Standard and Optional Boards

Item	Description	Spares Part Number
1	Memory board (SODIMM), 8-MB, 60 ns, nonparity	272108-001
*	Memory board (SODIMM), 16-MB, 60 ns, nonparity	272110-001
*	Memory board (SODIMM), 32-MB, 60 ns, non parity	220583-001
*	Memory board (SODIMM), 64-MB, 60 ns, non parity	273158-001
2	LED Status Board, 11.3-inch display	254958-001
*	LED Status Board, 12.1-inch display	255049-001
3	I/O Fixture Connector	254956-001
4	DC-DC Converter	254976-001
5	Audio Board	254957-001
6	System board, 120-MHz CPU	255010-001
*	System board, 133-MHz CPU with L2 cache	254949-001
*	System board, 150-MHz CPU with L2 cache, MMX	* Not yet available
7	Armada 1500 Series Telephony Modem	255014-001
* Not illustrated		

.....

4.5 Options

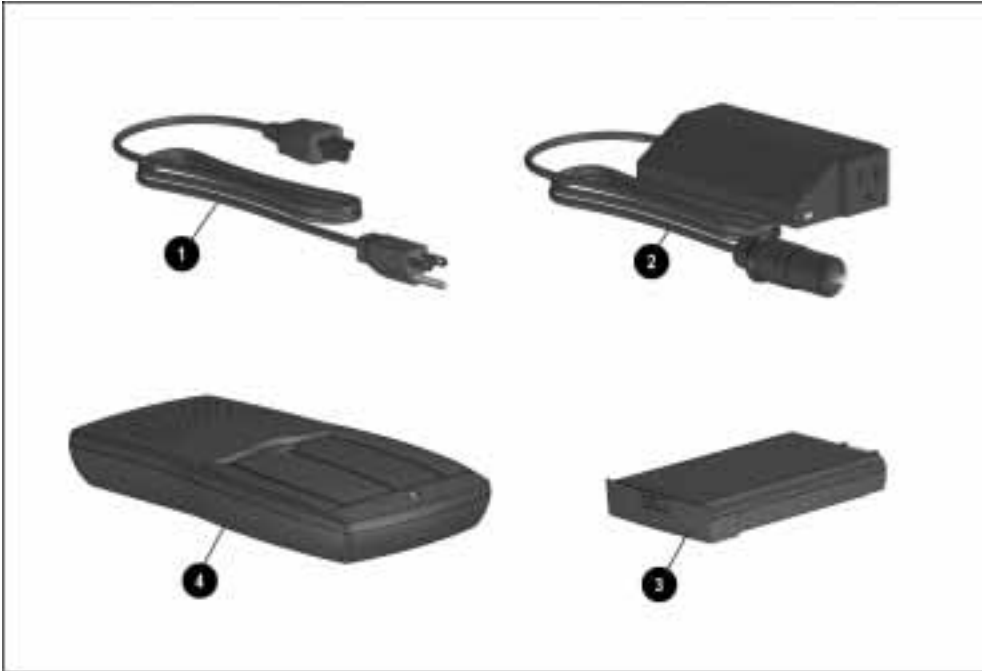

Figure 4-5. Options

Table 4-5
Options

Item	Description	Spares Part Number
1*	Power Cord (Australia/New Zealand)	246959-011
*	Power Cord (Denmark)	246959-081
*	Power Cord (Europe)	246959-021
*	Power Cord (Italy)	246959-061
*	Power Cord (Japan)	246959-291
*	Power Cord (Korea)	246959-AD1
*	Power Cord (Switzerland)	246959-AG1
*	Power Cord (UK and Singapore)	246959-031
	Power Cord (US/Canada)	246959-001
2	Automobile adapter	254970-001
3	Li-ion modular battery pack	254960-001
*	NiMH modular battery pack	254959-001
4	External battery charger	254970-001

* Not illustrated

.....

4.6 Miscellaneous Parts

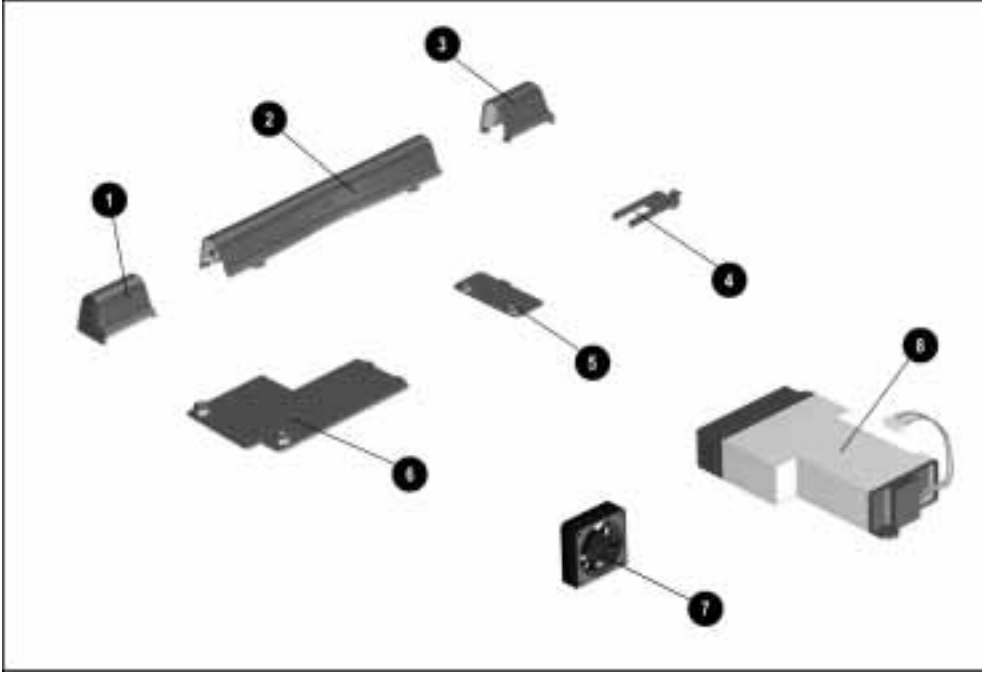

Figure 4-6. Miscellaneous Parts



**Table 4-6
Miscellaneous Parts**

Item	Description	Spares Part Number
	Plastics kit includes:	254981-001
1	Left clutch cover	
2	Microphone/Display cable cover	
3	Right clutch cover	
4	RTC Battery cover	
5	CD-ROM access door	
6	Modem access door	
7	Fan	254977-001
8	AC Power	254961-001
*	Miscellaneous Parts Kit (includes microphone)	254981-001
*	Screw kit	258819-001
*	Tool kit (includes connector removal tool, loop back plugs, and case utility tool)	100767-001
* Not illustrated		

4.8 Shipping Boxes

**Table 4-7
Shipping Boxes**

Description	Spare Part Number
Shipping Carton (5 ea)	254972-001
Shipping Carton, display (1 ea)	254973-001

4.9 Documentation

**Table 4-8
Documentation**

Description	Spare Part Number
Compaq Armada Family Illustrated Parts Map (10 ea)	255012-001
Compaq Armada Family Reference Guide	254984-001
Software CD Support	255097-001

Illustrated Parts for the Convenience Base

This chapter provides illustrated parts and spare parts references for the Compaq Armada 1500 Family of Convenience Bases. To review an illustrated parts breakdown of the convenience base, refer to the *Illustrated Parts Map* that comes with this guide.

.....

5.1 System Unit



Figure 5-1. Convenience Base

**Table 5-1
System Unit**

Item	Description	Spares Part Number
1	Convenience Base (Pass through model)	254988-001
*	Convenience Base (Ethernet model)	254987-001
*	Convenience Base (Ethernet model, BNC)	254989-001

* Not illustrated

**Table 5-2
Cables and Power Cords**

Description	Spares Part Number
* AC Power cord (Australia/New Zealand)	246959-011
* AC Power cord (Denmark)	246959-081
* AC Power cord (Europe)	246959-021
* AC Power cord (Italy)	246959-061
* AC Power cord (Japan)	246959-291
* AC Power cord (Korea)	246959-AD1
* AC Power cord (Switzerland)	246959-AG1
* AC Power cord (UK and Singapore)	246959-031
* AC Power cord (US/Canada)	246959-001

* Not illustrated

**Table 5-3
Options**

Description	Spares Part Number
* Monitor Stand	254990-001
* 100BaseT Ethernet Upgrade	225436-001

* Not illustrated

**Table 5-4
Shipping Boxes**

Description	Spares Part Number
Shipping Carton (5 ea)	254991-001

Removal and Replacement Preliminaries

This chapter provides general service information for the Compaq Armada 1500 Family of Personal Computers. Adherence to the procedures and precautions described in this chapter is essential for proper service.

6.1 Electrostatic Discharge

A sudden discharge of static electricity from a finger or other conductor can destroy static-sensitive devices or microcircuitry. Often the spark is neither felt or heard, but damage occurs. An electronic device exposed to electrostatic discharge (ESD) may not be affected at all and will work perfectly throughout a normal cycle. Or it may function normally for a while, then degrade in the internal layers, reducing its life expectancy.

Networks built into many integrated circuits provide some protection, but in many cases, the discharge contains enough power to alter device parameters or melt silicon junctions.

Generating Static

Table 6-1 shows how different activities generate static electricity and at different electrostatic voltage levels.

Event	Relative Humidity		
	10%	40%	55%
Walking across carpet	35,000 V	15,000 V	7,500 V
Walking across vinyl floor	12,000 V	5,000 V	3,000 V
Motions of bench worker	6,000 V	800 V	400 V
Removing DIPS from plastic tubes	2,000 V	700 V	400 V
Removing DIPS from vinyl trays	11,500 V	4,000 V	2,000 V
Removing DIPS from Styrofoam	14,500 V	5,000 V	3,500 V
Removing bubble pack from PCBs	26,000 V	20,000 V	7,000 V
Packing PCBs in foam-lined box	21,000 V	11,000 V	5,000 V

NOTE: 700 volts can degrade a product.

.....

Preventing Electrostatic Damage to Equipment

Many electronic components are sensitive to ESD. Circuitry design and structure determine the degree of sensitivity. The following proper packaging and grounding precautions are necessary to prevent damage:

- Protect all electrostatic parts and assemblies with conductive or approved containers or packaging.
- Keep electrostatic-sensitive parts in their containers until they arrive at static-free stations.
- Place items on a grounded surface before removing them from their container.
- Always be properly grounded when touching a sensitive component or assembly.
- Place reusable electronic-sensitive parts from assemblies in protective packaging or conductive foam.

Use transporters and conveyors made of antistatic belts and metal roller bushings. Mechanized equipment used for moving materials must be wired to ground and proper materials selected to avoid static charging. When grounding is not possible, use an ionizer to dissipate electric charges.

Removing Batteries

Compaq recommends that you remove all batteries from the computer before beginning the disassembly procedures. Failure to do so could cause damage to computer components.

Preventing Damage to Drives

To prevent static damage to hard drives, use the following precautions:

- Handle drives gently, using static-guarding techniques.
- Store drives in the original shipping containers.
- Avoid dropping drives from any height onto any surface.
- Handle drives on surfaces that have at least one inch of shockproof foam.
- Always place drives with the PCB assembly-side down on the foam.

Grounding Methods

The method for grounding must include a wrist strap or a foot strap at a grounded workstation. When seated, wear a wrist strap connected to a grounded system. When standing, use footstraps and a grounded floor mat.

Table 6-2
Static-Shielding Protection Levels

Method	Voltages
Antistatic plastic	1,500
Carbon-loaded plastic	7,500
Metallized laminate	15,000

.....

Grounding Workstations

To prevent static damage at the workstation, use the following precautions:

- Cover the workstation with approved static-dissipative material. Provide a wrist strap connected to the work surface and properly grounded tools and equipment.
- Use static-dissipative mats, heel straps, or air ionizers to give added protection.
- Handle electrostatic sensitive components, parts, and assemblies by the case or PCB laminate. Handle them only at static-free workstations.
- Avoid contact with pins, leads, or circuitry.
- Turn off power and input signals before inserting and removing connectors or test equipment.
- Use fixtures made of static-safe materials when fixtures must directly contact dissipative surfaces.
- Keep work area free of non-conductive materials such as ordinary plastic assembly aids and Styrofoam.
- Use field service tools, such as cutters, screwdrivers and, vacuums, that are conductive.
- Use a portable field service kit with a static dissipative vinyl pouch that folds out of a work mat. Also use a wrist strap and a ground cord for the work surface. Ground the cord to the chassis of the equipment undergoing test or repair.

Grounding Equipment

Use the following equipment to prevent static electricity damage to the equipment:

Wrist Straps are flexible straps with a minimum of 1 megohm +/- 10% resistance to the ground cords. To provide proper ground, a strap must be worn snug against the skin. On grounded mats without banana-plug connectors, connect a wrist strap with alligator clips.

Heel straps/Toe straps/Bootstraps can be used at standing workstations and are compatible with most types of boots and shoes. On conductive floors or dissipative floor mats, use straps on both feet with a minimum of 1 megohm resistance between operator and ground. To be effective, the conductive strips must be worn in contact with the skin.

.....

Recommended Materials and Equipment

Other materials and equipment that are recommended for use in preventing static electricity include:

- Antistatic tape
- Antistatic smocks, aprons, or sleeve protectors
- Conductive bins and other assembly or soldering aids
- Conductive foam
- Conductive table-top workstations with ground cord of 1 megohm of resistance
- Static dissipative table or floor mats with hard tie to ground
- Field service kits
- Static awareness labels
- Wrist straps and footwear straps providing 1 megohm +/- 10% resistance
- Material handling packages
- Conductive plastic bags
- Conductive plastic tubes
- Conductive tote boxes
- Metal tote boxes
- Opaque shielding bags
- Transparent metallized shielding bags
- Transparent shielding tubes

6.2 Service Considerations

Listed below are some considerations to keep in mind during the disassembly and assembly of the computer.

Tool Requirements

- Magnetic Torx T-8 screwdriver
- Flat-bladed screwdriver (optional)
- Tool kit, Compaq part number 100767-001 (includes case utility tool, connector removal tool, and loop back plugs)
- 7-mm socket wrench
- 5-mm socket wrench/screw driver
- Preloaded application diskettes

IMPORTANT: To reassemble the computer, set the Torx T-8 screwdriver to 3-inch lbs.

Cables and Connectors

Apply only the tension required to seat or unseat the cables during insertion or removal from connectors. Handle cables by the connector or pull tabs whenever possible. In all cases, avoid bending, twisting, or tearing the cables, and ensure that cables are placed in such a way that they cannot be caught or snagged by parts being removed or replaced.



CAUTION: When servicing these computers, ensure that cables are placed in their proper location during the reassembly process. Improper cable placement can cause severe damage to the unit.

6.3 Serial Number

The computer serial numbers should be provided to Compaq whenever requesting information or ordering spare parts. The serial number is located on the rear of the CPU.

Computer Removal and Replacement Procedures

This chapter provides the removal and replacement procedures for the computer.

7.1 Serial Number

The computer serial number should be provided to Compaq support when requesting information or ordering spare parts. The serial number is displayed on the rear of the CPU (Figure 7.1).



Figure 7-1. Serial Number

7.2 Disassembly Sequence Chart

This chart shows the order in which disassembly procedures are provided:

7.4	Preparing the Computer for Disassembly
	Disconnecting AC Power
	Undocking the Computer
	Battery Pack
	DualBay Device
	PC Cards
7.5	Modem
7.6	CD-ROM Drive
7.7	Keyboard
7.8	Memory
7.9	Hard Drive
7.10	Lithium Real Time Clock Battery
7.11	Microphone/Display Cable Cover and Microphone
7.12	Clutch Covers/Display Assembly
	Clutch Covers
	Display Assembly
	Display Clutches
	Display Latches
7.13	Top Cover Assembly
	Power Button
	Suspend Button
	Touchpad Mouse Buttons
7.14	LED Status Panel
7.15	Audio Board, Speakers, and Audio Cable
7.16	DC-DC Converter
7.17	Fan
7.18	I/O Fixture Connector
7.19	System Board
7.20	AC Power
7.21	External Components

7.3 Design Overview

This section presents a design overview of the computer. The overview is limited to field replaceable parts. All replacement parts are listed in Chapter 4.

7.3.1 System Unit

The computer is a traditional clamshell design with a display unit attached to a system unit. The computer opens to reveal a backlit LCD display and a full-sized keyboard. The display is designed for a continuously adjustable tilt angle.

7.3.2 Internal Boards

The system electronics are integrated on five printed circuit assemblies: the LED status panel, audio board, system board, serial-parallel port board, and the DC-DC converter board.

- The LED status board connects the system board to the display cables and supports the status LEDs.
- The DC-DC converter board creates the CPU (2.9v or 2.5v) and system voltages (3.3v and 5v) from the battery or AC/DC input.
- The system board integrates the processor, memory, level 2 cache, local bus video adapter, PCMCIA/CardBus adapter and audio controller.

Processor

The processor located on the system board for the 120 MHz and 133 MHz models is the Intel P54LM Pentium processor.

Memory

Base memory is 16-MB with 8-, 16-, 32-, or 64-MB of optional expansion memory. Base memory is onboard memory built into the system board. Expansion memory consists of one memory expansion board available as a user installable option.

Cache

Level 2 cache, available on some models, is soldered on the system board. The level 2 cache 256-Kbyte is a pipelined synchronous burst design. It is not user upgradable.

Audio Controller

The audio controller is located on the system board. The audio amplifiers and connectors are on the audio board printed circuit assembly.

.....

PCMCIA/CardBus and Video Adapter Controller

The PCMCIA/CardBus adapter is based on the Texas Instrument PCI1130 PC to CardBus controller unit. The local bus video adapter is the Cirrus CL-GD 7548 controller.

- The serial-parallel port board expands the serial and parallel signals from the system board to the serial and parallel expansion connectors.
- The audio board supports the microphone and headphone jacks, the volume control switches, and the amplifier and equalization circuitry.

7.3.3 Video system

The standard video subsystem consists of:

- An internal LCD Display
- 11.3 inch SVGA CSTN display
- 12.1 inch SVGA CTFT display
- 1 Megabyte frame buffer
- An inverter to supply AC power to the LCD back-light system
- A standard external VGA connector for use with CRTs and other VGA compatible displays
- 40 KByte of Video ROM

7.4 Preparing the Computer for Disassembly

Before beginning the removal and replacement procedures, complete the following procedures:

1. Disconnect the AC power and any external devices (Section 7.4.1)
2. Remove the battery pack (Section 7.4.3).
3. Remove the DualBay device (Section 7.4.4).
4. Remove any PC Cards (Section 7.4.5)

7.4.1 Disconnecting the AC Power

The first procedure that should be performed on the computer is to disconnect the power supply and any external devices.

1. Close all applications and turn off the computer.
2. Turn off and disconnect any external devices.
3. Disconnect the AC power cord from the power source.
4. Disconnect the AC power from the computer.

If the computer is docked in the convenience base, see Section 7.4.2 for undocking instructions.

7.4.2 Undocking the Computer

If the computer is docked in the convenience base, it must be undocked before performing additional work. Complete the following steps to undock the computer. If the computer is not docked in the convenience base, proceed to Section 7.4.3.

1. Disconnect the AC power and any external cables (Section 7.4.1).
2. Close the computer.
3. Pull the docking lever forward to undock the computer.
4. Lift the computer from the convenience base to remove.

7.4.3 Battery Pack

The battery pack should be removed before performing any internal maintenance on the computer.



WARNING: Metal objects can damage the battery pack as well as the battery contacts in the battery compartment. To prevent damage, do not allow metal objects to touch the battery contacts. Place only the battery pack for the Compaq Armada Personal Computer into the battery compartment. Do not force the battery pack into the handle if insertion does not occur easily.



WARNING: Do not crush, puncture, or incinerate the battery pack. Do not dispose of in water. Do not expose to temperatures higher than 60°C. Do not open a battery pack, as this damages the pack, makes it unserviceable, and exposes potentially harmful battery components. There are no field-serviceable parts located inside the battery pack.

To remove the battery pack from the computer, complete the following steps:



1. Turn the computer bottom side up.
2. Slide the battery release latch .
3. Remove the battery pack .



Figure 7-2. Removing the Battery Pack

.....

To install the battery pack:

1. Insert the battery into the battery compartment.
2. Push firmly until the battery pack is seated into place .



Figure 7-3. Inserting the Battery Pack



CAUTION: Installing the battery pack upside down can cause the contacts to break.

7.4.4 DualBay Devices



CAUTION: The device in the DualBay must be removed prior to performing maintenance on the computer.



WARNING: Metal objects can damage the battery pack as well as the battery contacts in the battery compartment. To prevent damage, do not allow metal objects to touch the battery contacts. Place only the battery pack for the Compaq Armada 1500 Family of Personal Computers into the battery compartment. Do not force the battery pack if insertion does not occur easily.



WARNING: Do not crush, puncture, or incinerate the battery pack. Do not dispose of in water. Do not expose to temperatures higher than 60°C. Do not open a battery pack, as this damages the pack, makes it unserviceable, and exposes potentially harmful battery components. There are no field-serviceable parts located inside the battery pack.

NOTE: If a battery pack is used in the DualBay, use the battery release latch to release the battery.

Either a diskette drive or a modular battery pack may be installed into the DualBay. The device in the DualBay must be removed prior to performing maintenance on the computer. For convenience, a diskette drive is depicted in this sequence. To remove the DualBay device, complete the following steps:





1. Turn the computer bottom side up.
2. Pull the diskette drive release latch towards the front of the computer .
3. Remove the diskette drive .



Figure 7-4. Removing the DualBay Device

7.4.5 PCMCIA

Remove any installed PC (PCMCIA) Cards before performing any service on the computer. To remove a PC Card, complete the following steps:

1. Rotate the PC Card eject lever to the forward position .
2. Press the PC Card eject button .
3. Pull the PC Card out of the PC Card slot .

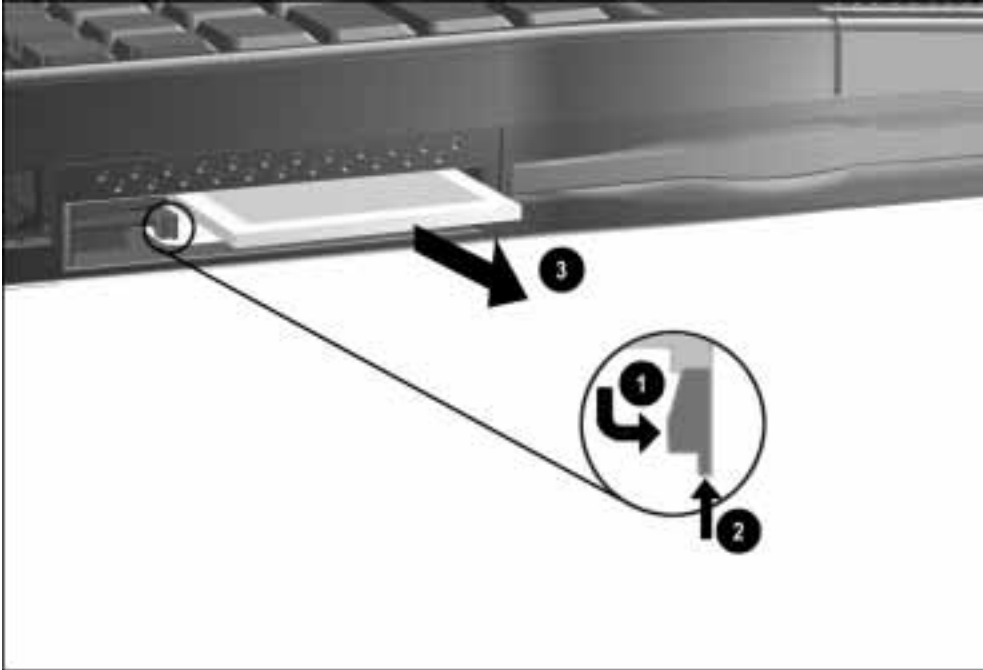

Figure 7-5. Removing the PC Card



To install a PC Card, insert the card into the slot and press firmly until it is seated.

NOTE: Before replacing the system board, the PC Card eject levers must be in the forward position. See Section 7.18 on removing the system board.

7.5 Modem

The modem is standard on some models and an upgrade option available on some models. If the model is not equipped with a modem, the modem compartment is sealed off by a protective plate.

For models equipped with a modem, complete the following steps for removal.

1. Turn the computer bottom side up.
2. Remove two screws from the modem access door.
3. Remove the modem access door .
4. Carefully pull the modem board release tab .

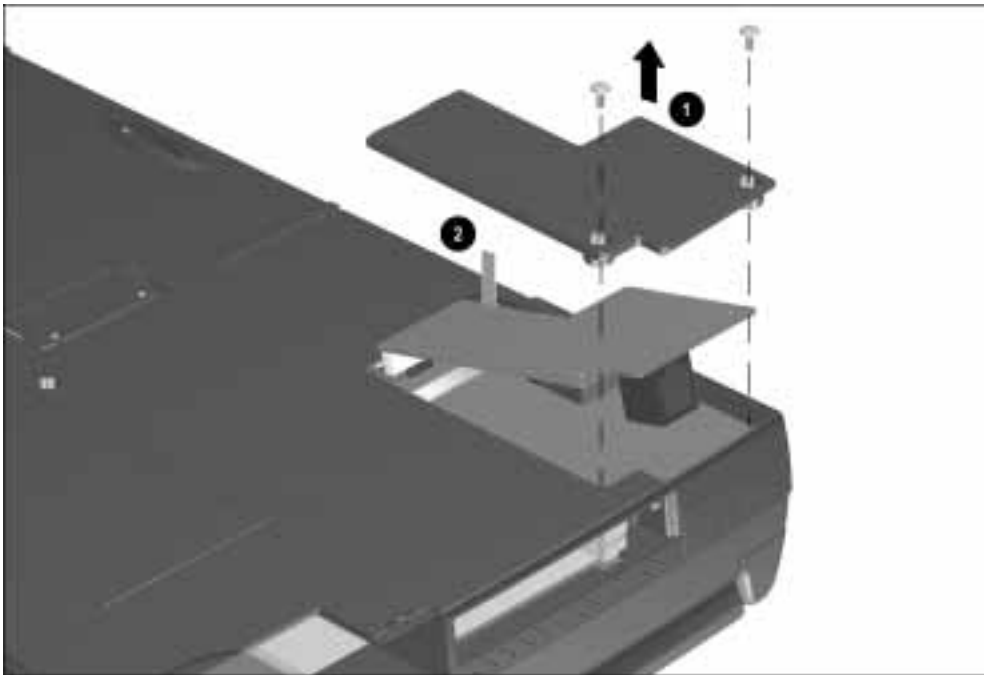

Figure 7-6. Removing the Modem

To replace or install the modem, reverse the procedure.

NOTE: When installing the modem, be sure that the modem release tab is folded on top of the modem before replacing the modem access door.

7.6 CD-ROM Drive

The CD-ROM drive is standard on some models and an upgrade option for other models. If the model does not have a CD-ROM drive, the CD-ROM compartment is sealed off by a protective plate. To remove the CD-ROM drive and access door, complete the following steps:

1. Turn the computer bottom side up.
2. Remove two screws from the CD-ROM drive access door.



Figure 7-7. Removing the CD-ROM Drive Access Door

3. Remove the CD-ROM drive.

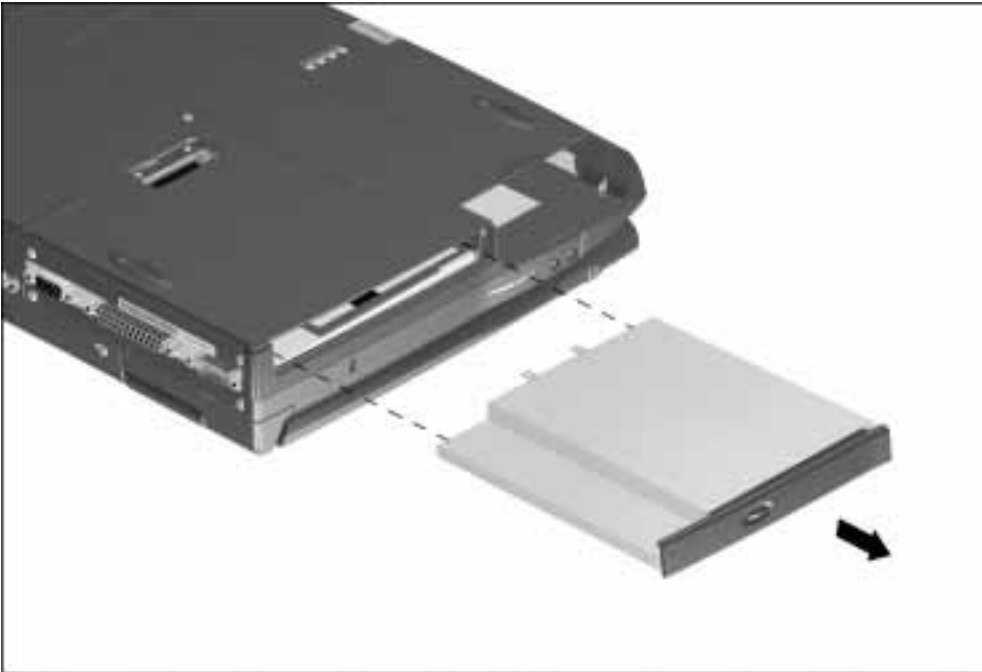



Figure 7-8. Removing the CD-ROM Drive

To install the CD-ROM drive reverse the procedure.

7.7 Keyboard

To remove the keyboard, complete the following procedures.

1. Disconnect the AC power and any external devices (Section 7.4.1).
2. Remove the battery pack (Section 7.4.3).
3. Remove the DualBay device (Section 7.4.4).
4. Remove any PC Cards (Section 7.4.5).
5. Turn the computer bottom side up.
6. Remove the screws near the rear of the computer from the battery and DualBay compartments and from the bottom of the base . These screws remove the keyboard.
7. Remove the upper screws  from the battery and DualBay compartments. These are the remaining base enclosure screws.

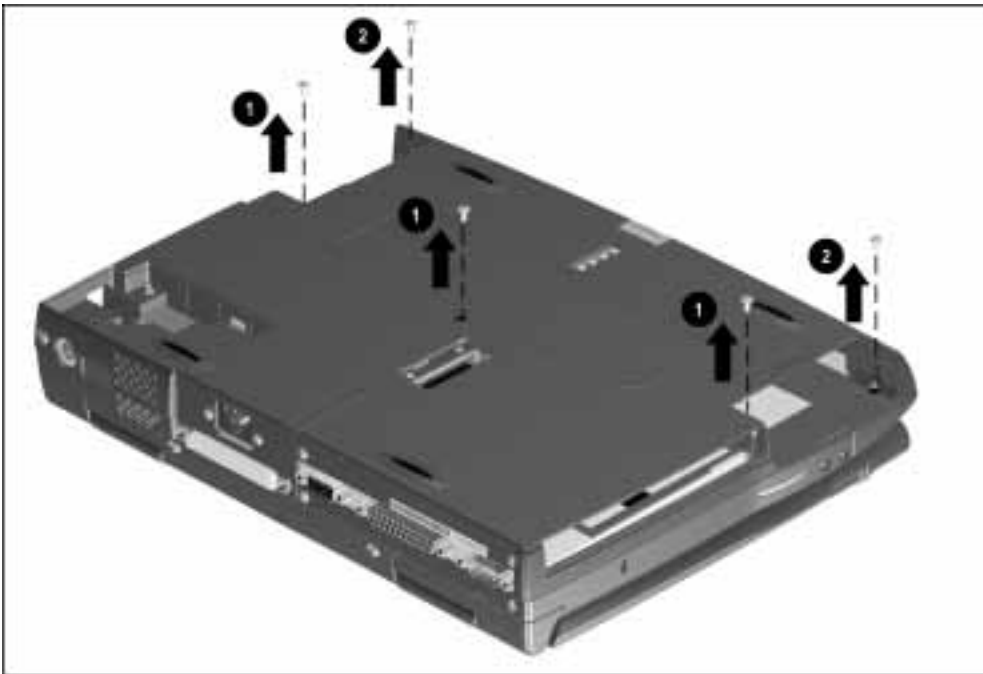

Figure 7-9. Removing the Keyboard Screws

-
8. Turn the computer topside up.
 9. Use a case utility tool to carefully lift up the corner of the keyboard.
 10. Disconnect the ZIF connector.

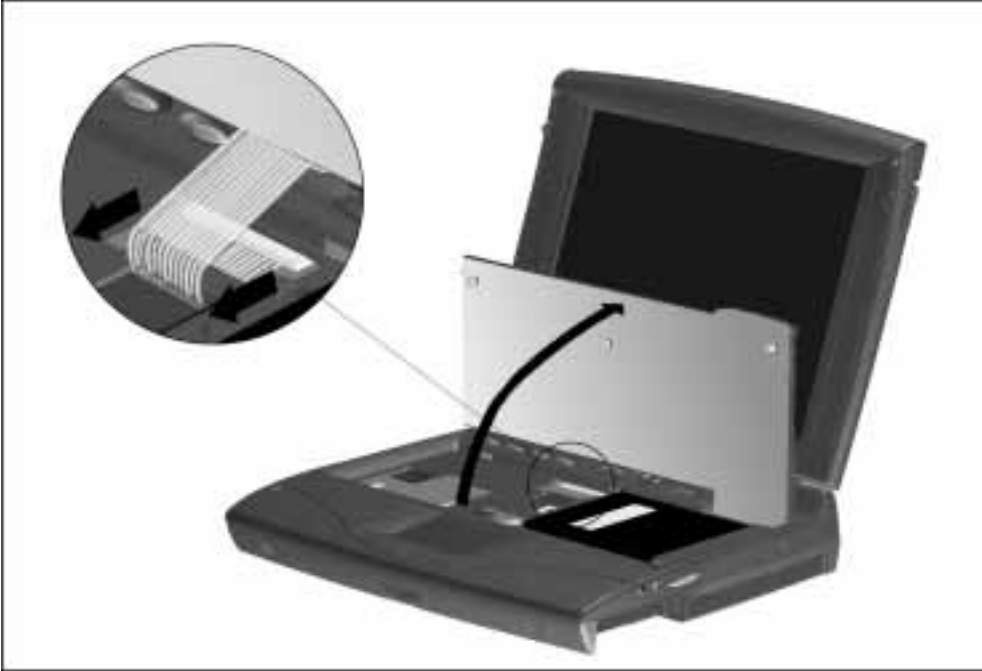



Figure 7-10. Lifting the Keyboard

-
11. Carefully pull the ZIF connector away from the connector .
 12. Lift the keyboard cable strain relief tab  and keyboard from the computer

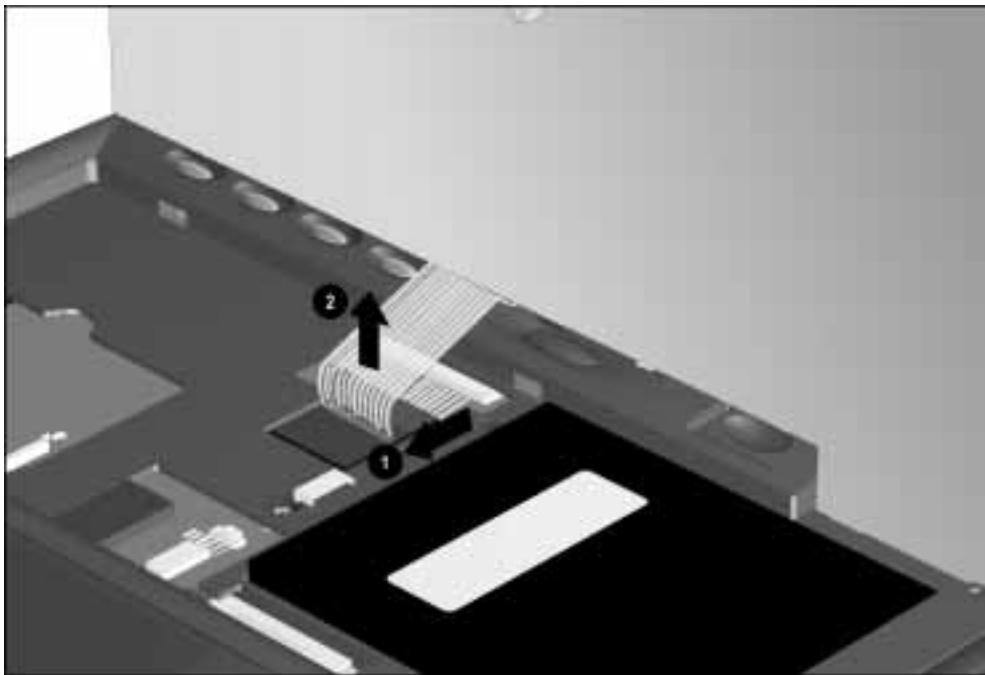

Figure 7-11. Removing the Keyboard

To replace the keyboard, reverse the steps.



7.8 Memory Board

If a memory expansion board option has been previously installed in the computer, it must be removed before another is installed. To remove the memory board, complete the following steps:

1. Disconnect the AC power and any external devices (Section 7.4.1).
2. Remove the battery pack (Section 7.4.3).
3. Remove the DualBay device (Section 7.4.4).
4. Remove any PC Cards (Section 7.4.5).
5. Raise the keyboard (Section 7.7).



CAUTION: If you need to remove the memory expansion board, be sure to release the locking tabs that secure the memory board in the slot. If the tabs are not released, the connectors may break and cause irreparable damage to the system board.

6. Release the right  and left  locking tab at each end of the memory expansion board. This releases the memory board and allows it to rotate upward to ease removal.

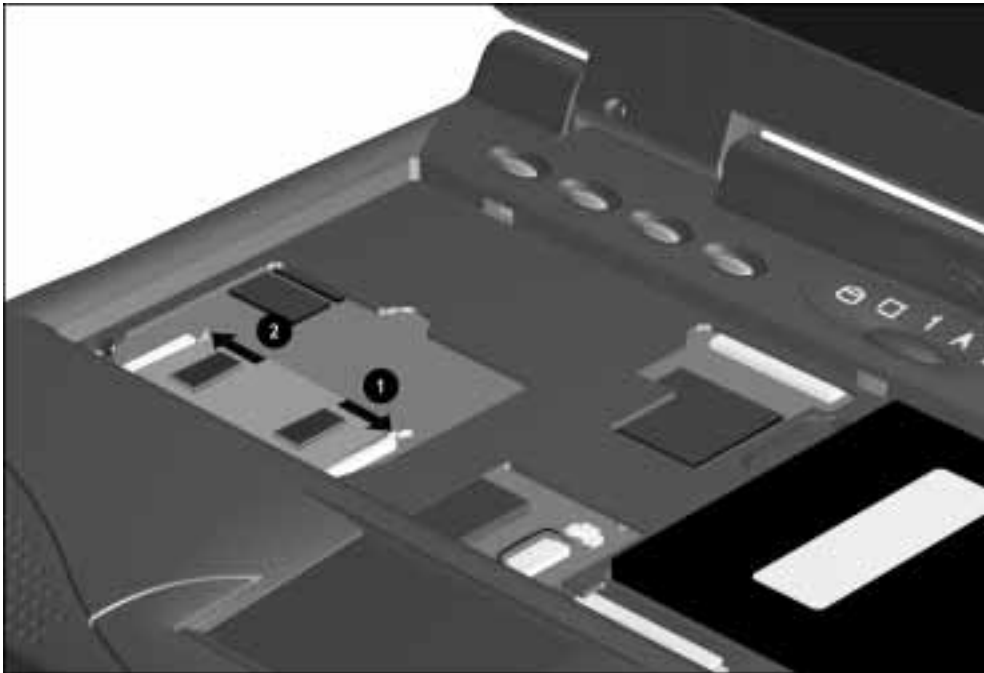

Figure 7-12. Releasing the Memory Expansion Board

.....

7. Lift the free edge of the memory board slightly and pull it straight out of the slot.

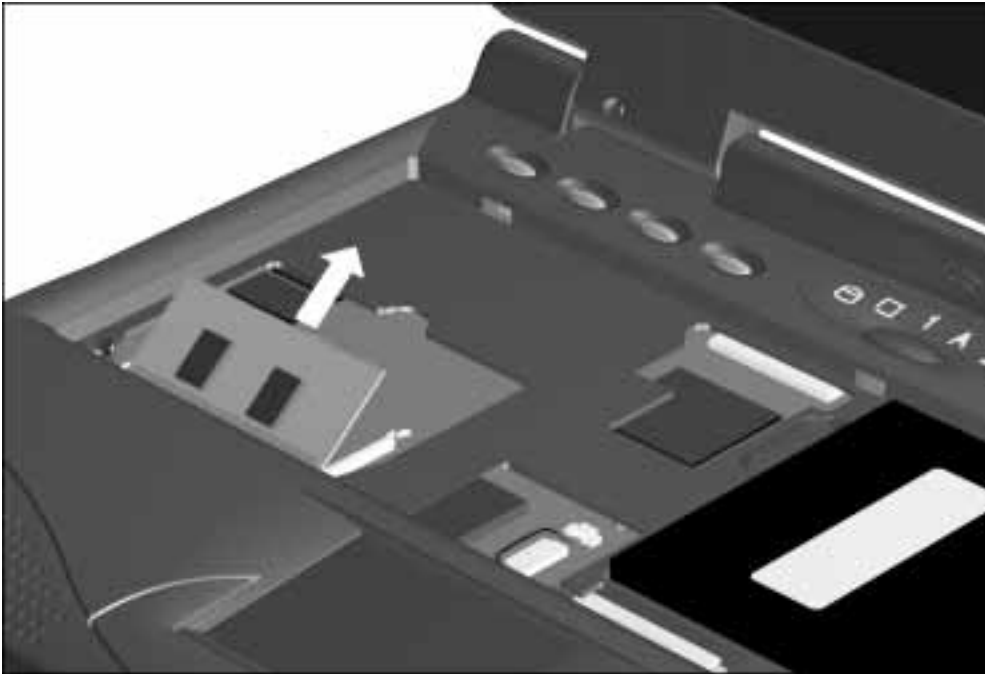



Figure 7-13. Removing the Memory Expansion Board

.....

To install the memory board, complete the following steps:

1. Insert the memory board into the memory slot .
2. Pivot the memory board so that it lays flat in the memory compartment .
3. Push the memory board firmly into place to seat the connections and to engage the locking tabs.

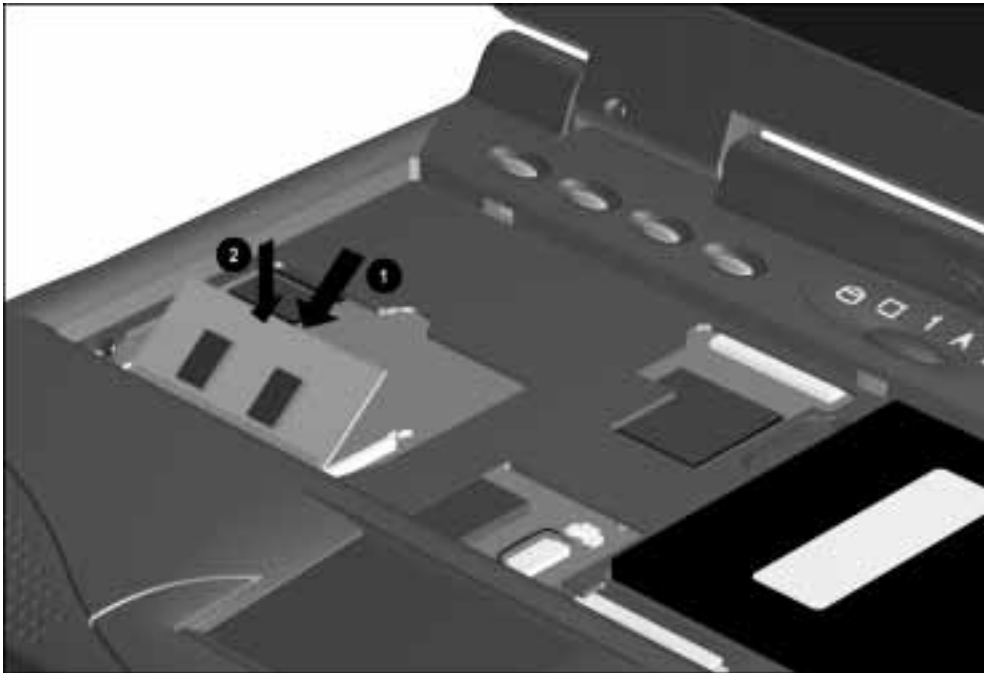

Figure 7-14. Installing the Memory Board

7.9 Hard Drive

NOTE: The 3-inch hard drive or the 2.5-inch hard drive with carrier are interchangeable.

The hard drive is held in place with two screws and a retaining bracket. To remove the hard drive and bracket, complete the following steps:

1. Disconnect the AC power and any external devices (Section 7.4.1).
2. Remove the battery pack (Section 7.4.3).
3. Remove the DualBay device (Section 7.4.4).
4. Remove any PC Cards (Section 7.4.5).
5. Raise the keyboard (Section 7.7).
6. Remove two screws and the hard drive retaining bracket that secure the hard drive in place.

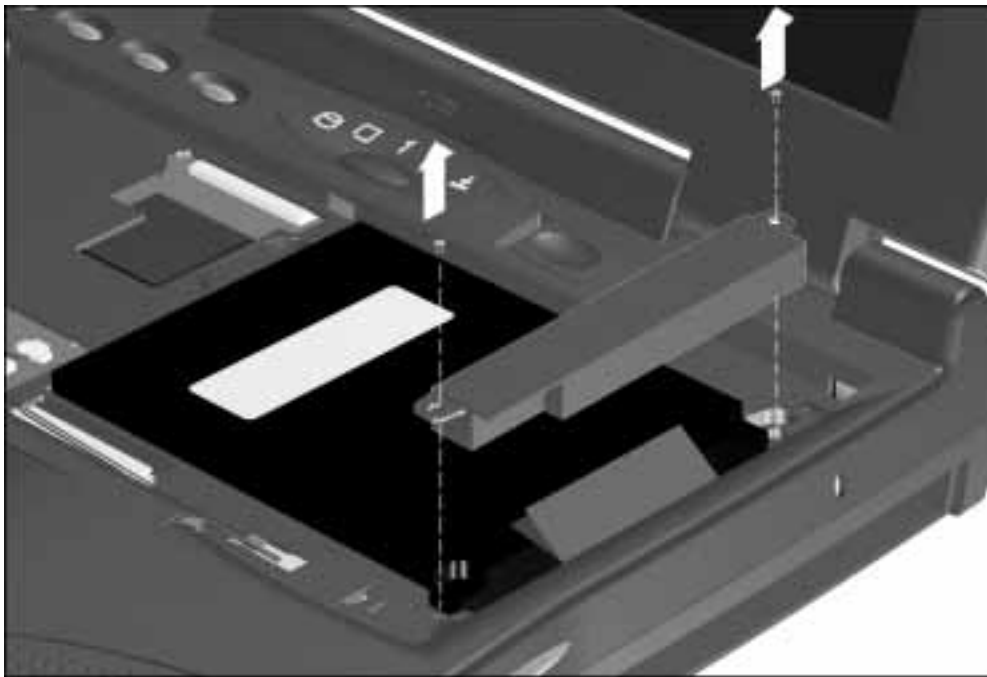

Figure 7-15. Removing the Hard Drive Bracket

-
7. Slide the hard drive to the right.
 8. Lift the hard drive from the hard drive compartment.

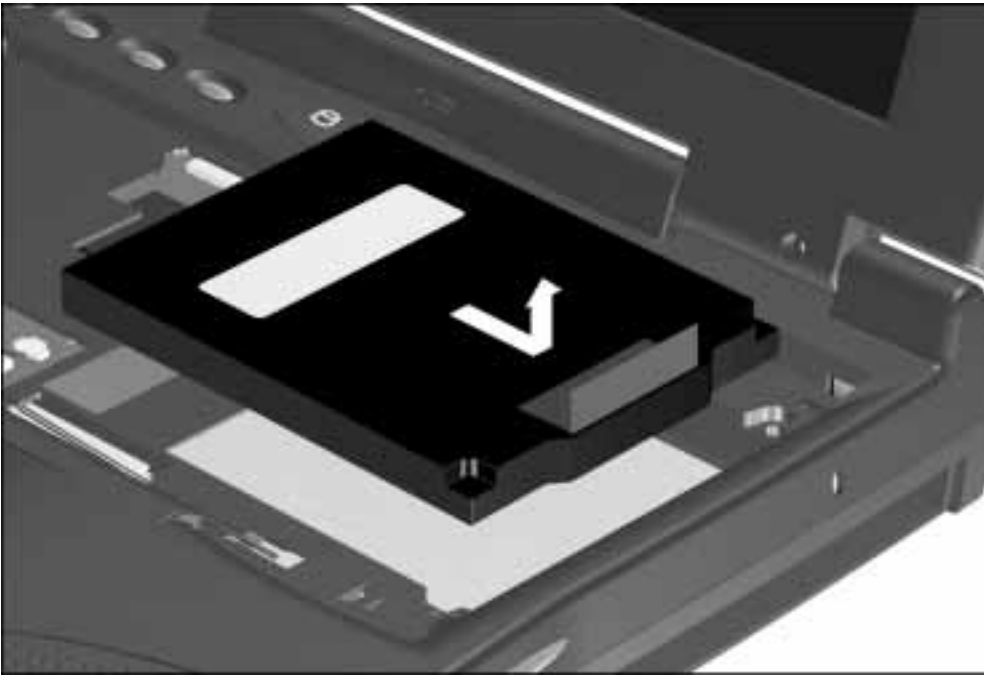

Figure 7-16. Removing the Hard Drive

Reverse the above procedure to install the hard drive.

7.10 Lithium Real Time Clock Battery



WARNING: There is a risk of explosion and injury if the battery is incorrectly replaced or handled improperly. Do not attempt to recharge, disassemble, immerse in water, or dispose of it in fire. Replacement should be done using the Compaq spare part for this computer.



CAUTION: To prevent damaging the RTC battery cable, rock the connector from side to side to disconnect it.

To remove the Lithium Real Time clock (RTC) battery, complete the following steps:

1. Disconnect the AC power and any external devices (Section 7.4.1).
2. Remove the battery pack (Section 7.4.3).
3. Remove the DualBay device (Section 7.4.4).
4. Remove any PC Cards (Section 7.4.5).
5. Raise the keyboard (Section 7.7).
6. Remove the lithium real time clock (RTC) battery cover.

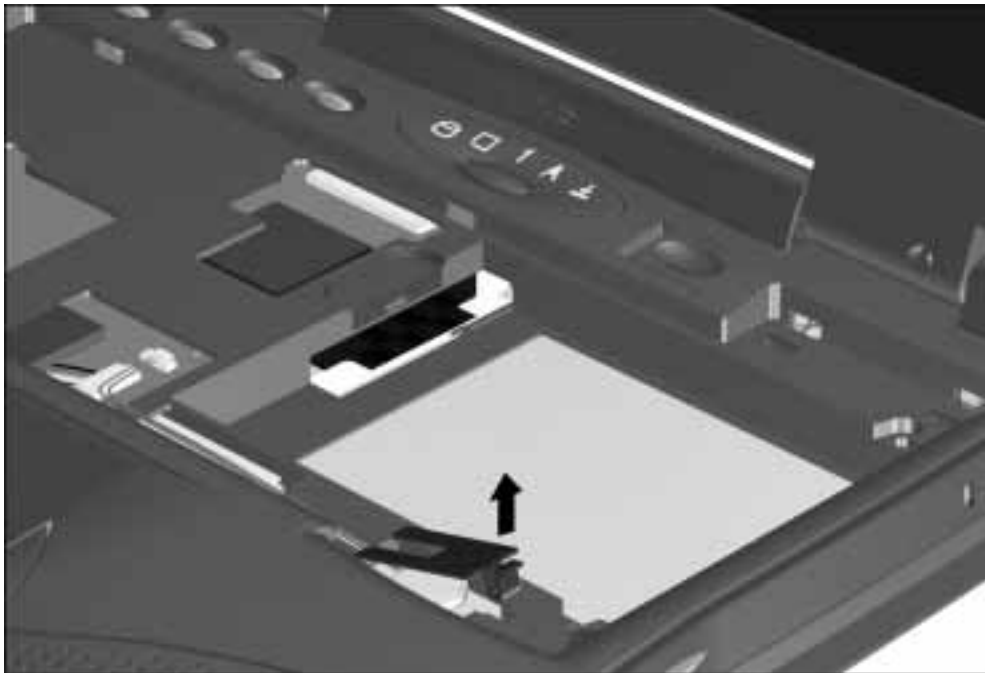



Figure 7-17. Removing the RTC Battery Cover

7 Disconnect the RTC battery connector from the system board .

8. Remove the RTC battery .

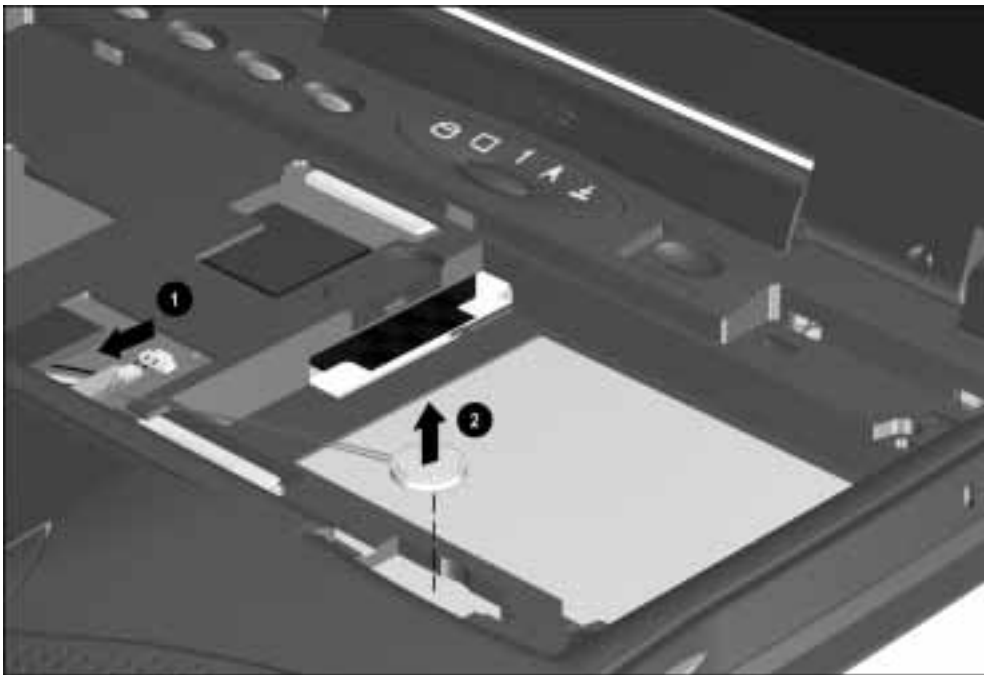

Figure 7-18. Removing the RTC Battery

Reverse the procedure to install a replacement RTC battery.



7.11 Microphone/Display Cable Cover and Microphone

To remove the microphone and microphone/display cable cover, complete the following steps:

1. Disconnect the AC power and any external devices (Section 7.4.1).
2. From the rear of the computer, remove two screws securing the microphone/display cable cover from the base enclosure.



Figure 7-19. Removing the Microphone/Display Cable Cover Screws

-
3. Remove the microphone/display cable cover by rotating the cover  and lifting it from the rear of the computer .

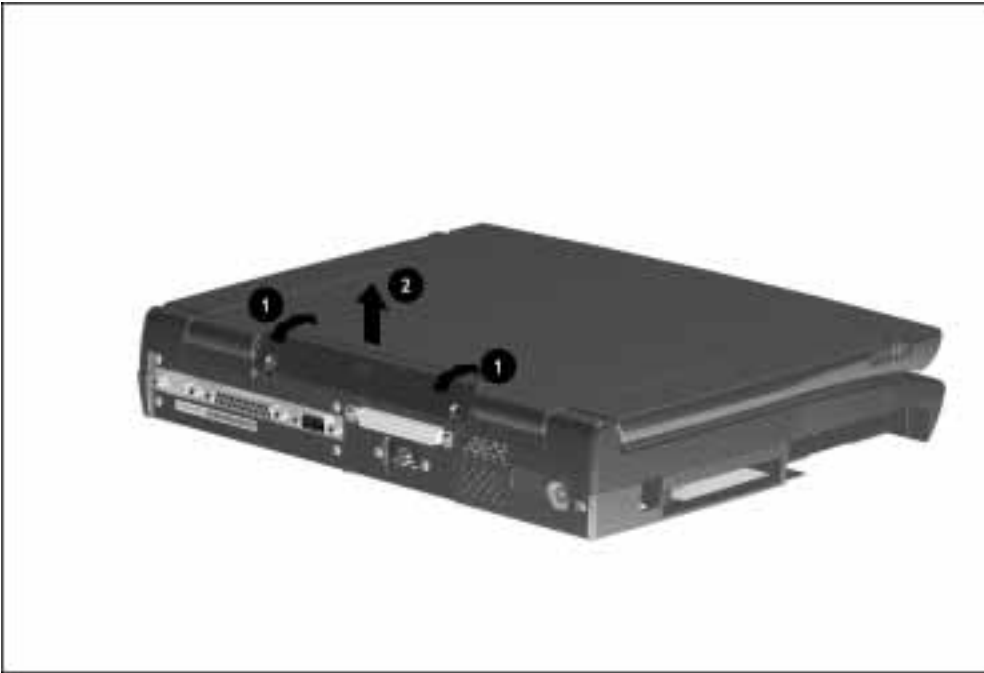

Figure 7-20. Removing the Microphone/Display Cable Cover

-
4. Disconnect the microphone from the audio cable.
 5. Remove the microphone.

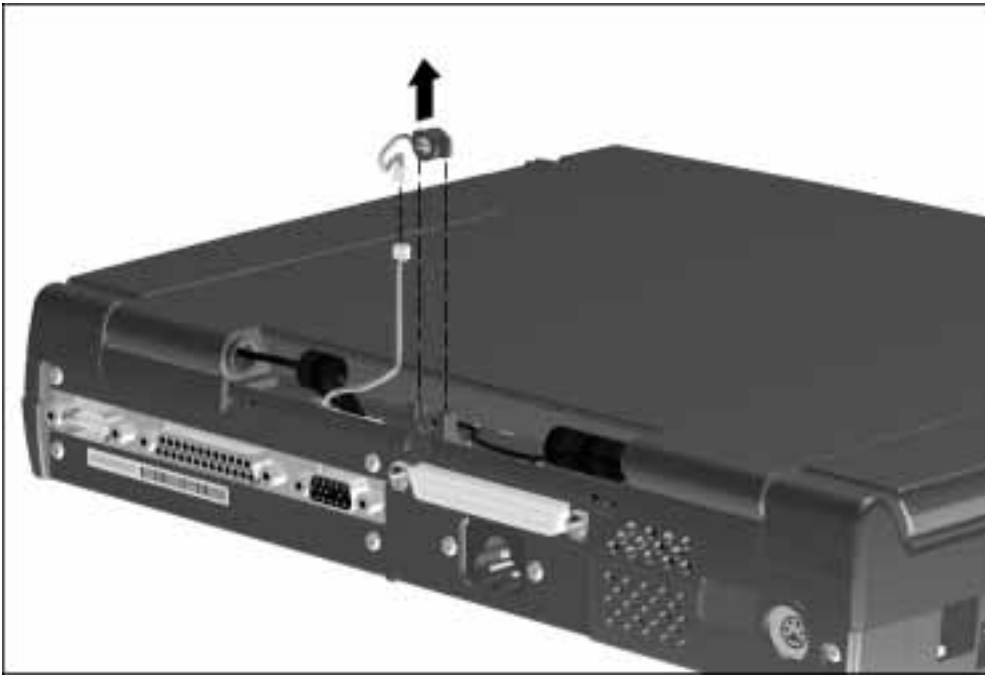

Figure 7-21. Removing the Microphone

7.12 Clutch Covers/Display Assembly

7.12.1 Clutch Covers



CAUTION: Do not reuse the clutch screws removed from the old display. These screws may back out of the display clutches and cause the display assembly to loosen from the base enclosure.

To remove the left and right clutch covers, lift them from the ends of the computer.





Figure 7-22. Removing the Clutch Covers

Reverse the procedure to install the clutch covers.

7.12.2 Display Assembly

To remove the display assembly, complete the following procedures:

1. Disconnect the AC power and any external devices (Section 7.4.1).
2. Remove the battery pack (Section 7.4.3).
3. Remove the DualBay device (Section 7.4.4).
4. Remove any PC Cards (Section 7.4.5).
5. Remove the microphone/display cable cover (Section 7.11).
6. Remove the clutch covers (Section 7.12.1).
7. Remove two screws from each clutch and the clutch tension plate that secure the display to the base enclosure .
8. Disconnect the display cables from the base enclosure .
9. Lift the display assembly from the base enclosure

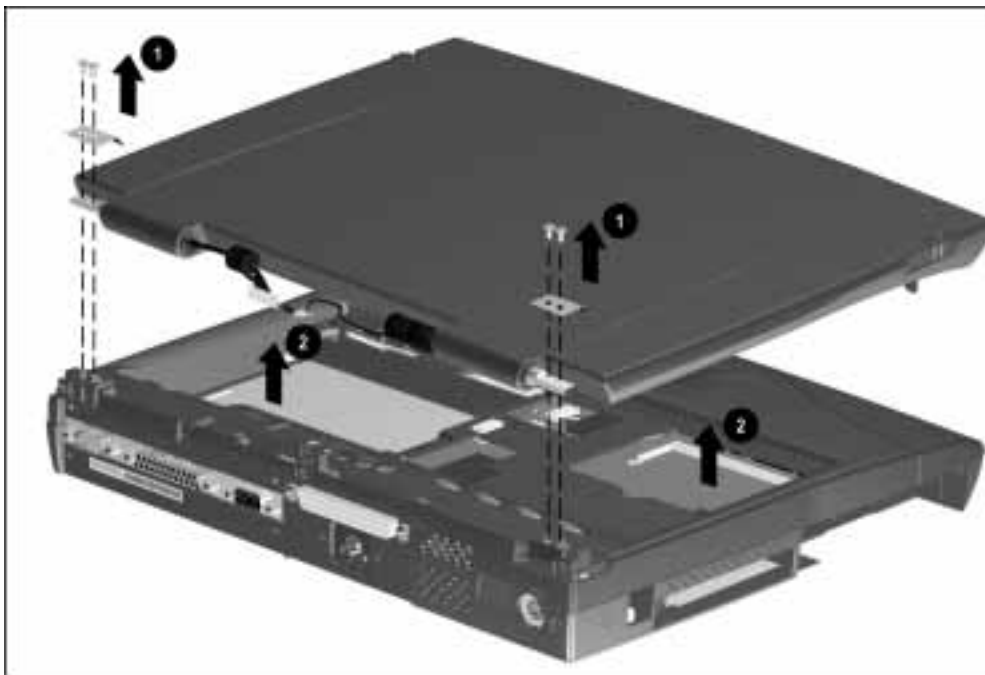

Figure 7-23. Removing the Display Assembly

Reverse the procedure to replace the display assembly.



CAUTION: To avoid damaging the display and ground cables, attach the ground cable before attaching the display cables when replacing the display assembly.

.....

7.12.3 Clutches

The two clutches act as hinges for the display assembly. To remove the clutches, complete the following procedures:

1. Remove the clutch covers (Section 7.12.1).
2. Remove the display assembly (Section 7.12.2).
3. Remove the display screw covers and screws.

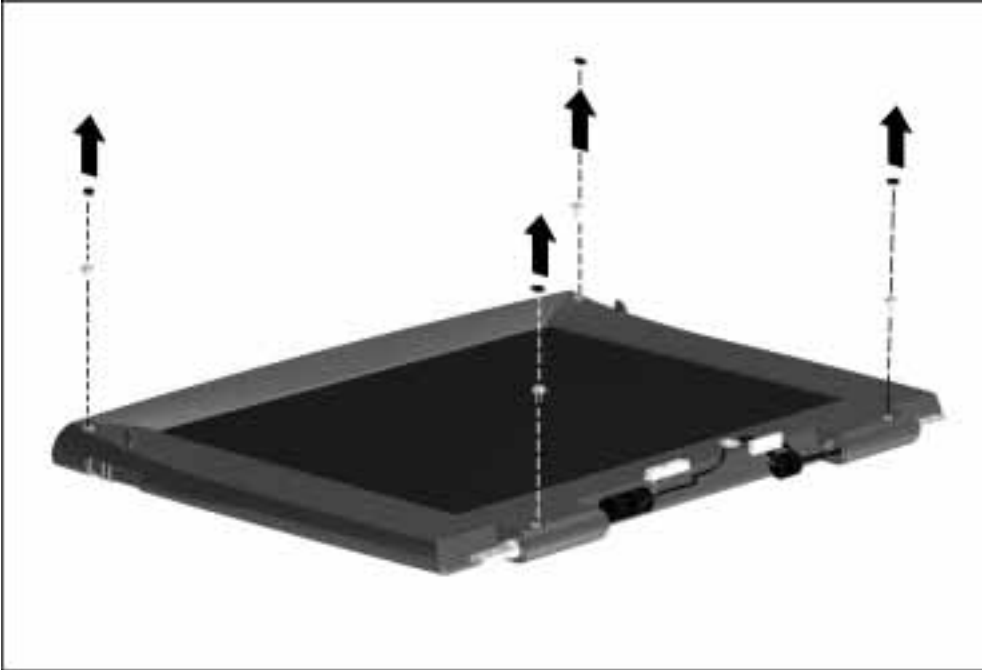

Figure 7-24. Removing the Display Screw Covers and Screws

-
4. Use the case utility tool to carefully pry up the display bezel.
 5. Remove the display bezel.

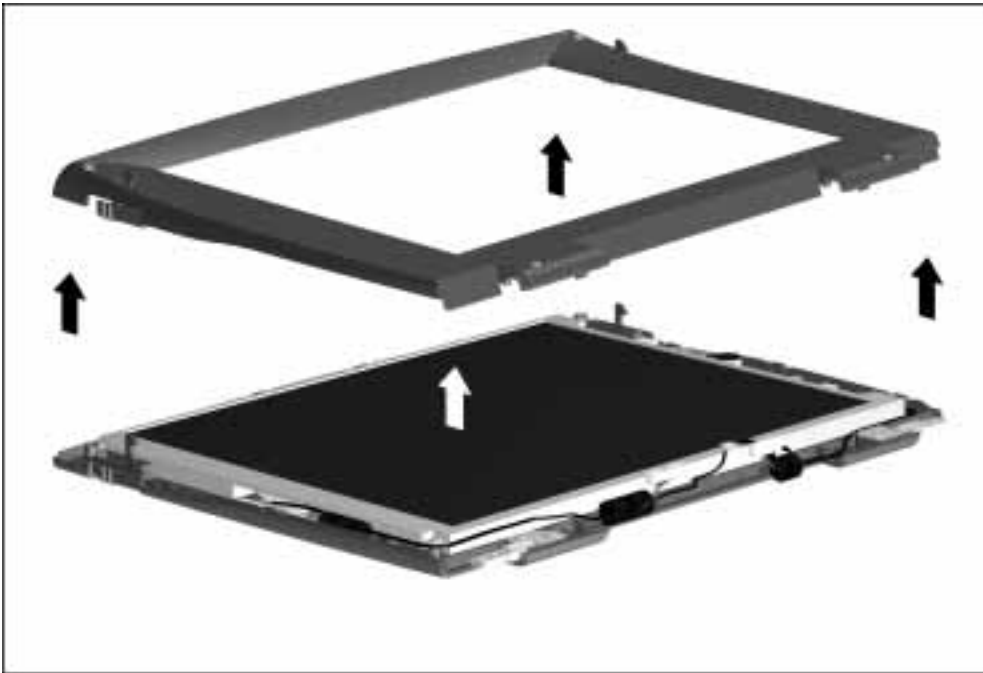

Figure 7-25. Removing the Display Bezel

-
6. Remove two clutch screws and the retaining plates that secure the clutches to the display panel.

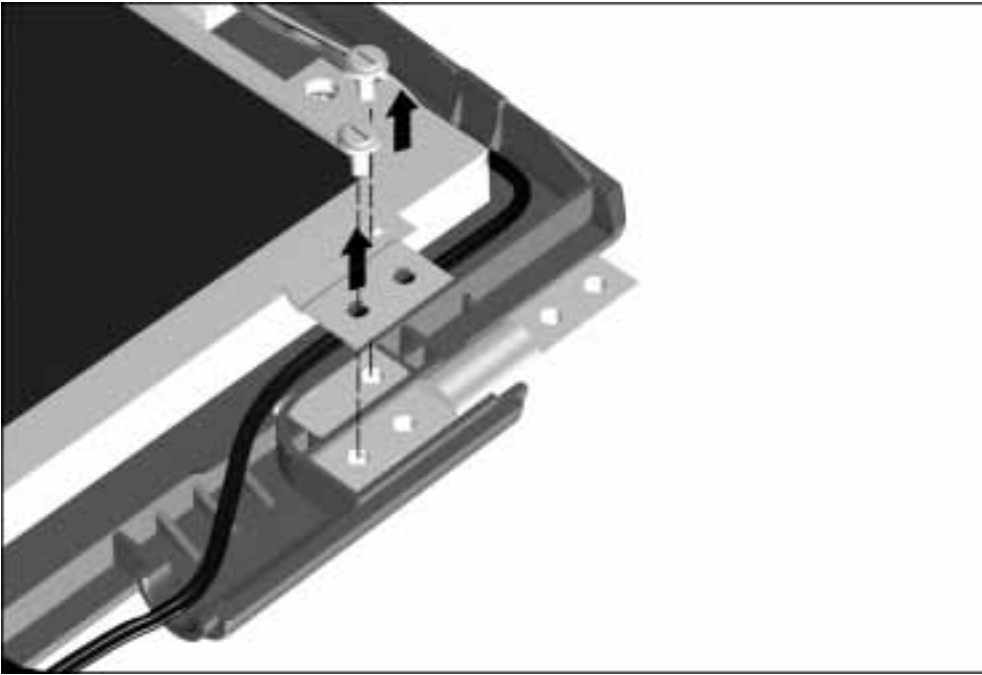

Figure 7-26. Removing the Clutch Screws and Retaining Plate

.....

7. Remove the display clutch.

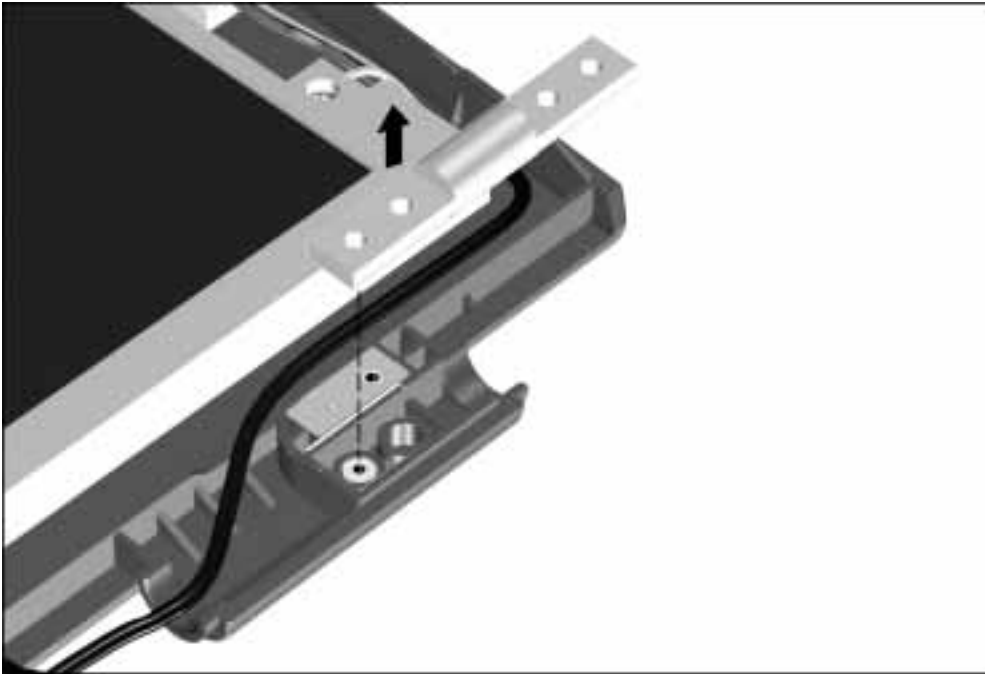

Figure 7-27. Removing the Display Clutches

To replace the display clutches, reverse the steps.

.....

7.12.4 Display latches

1. Remove the display assembly (Section 7.12.1).
2. Remove the display bezel (Section 7.12.3).
3. Remove the display latch springs.

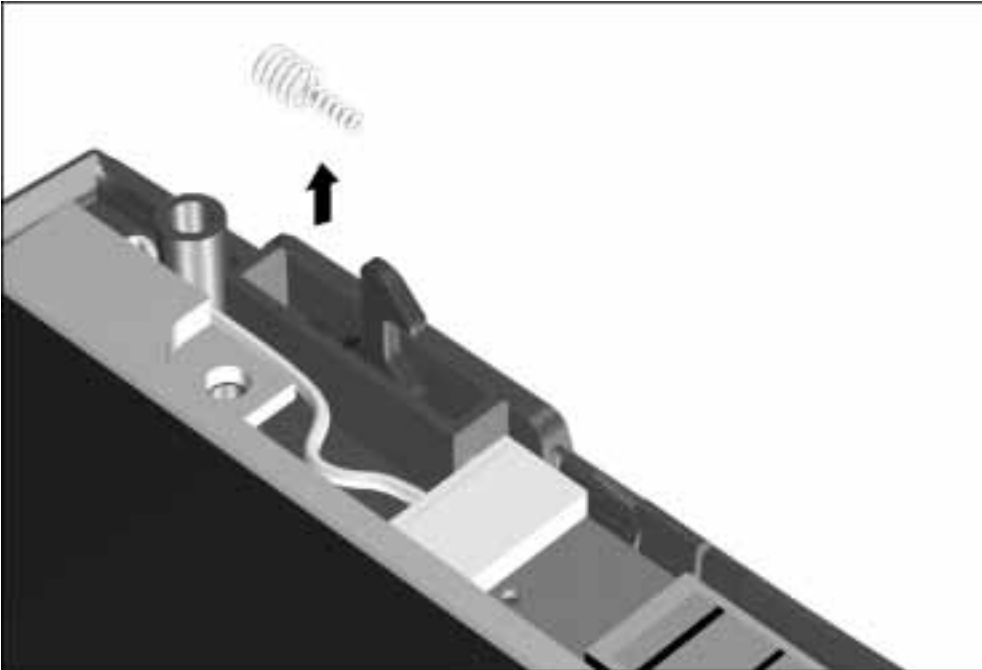

Figure 7-28. Removing the Display Latch Springs

4. Push the display latch back  and down .

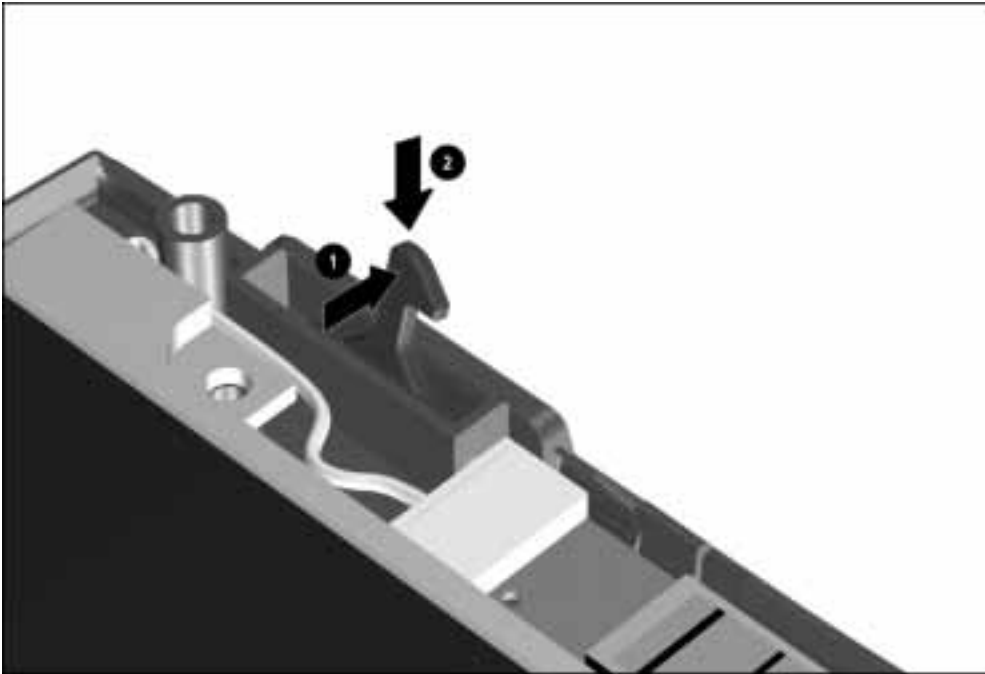

Figure 7-29. Removing the Display Latch

To replace the display latches, reverse the steps.

7.13 Top Cover Assembly

To remove the top cover assembly, complete the following procedures:

1. Disconnect the AC power and any external devices (Section 7.4.1).
2. Remove the battery pack (Section 7.4.3).
3. Remove the DualBay device (Section 7.4.4).
4. Remove any PC Cards (Section 7.4.5).
5. Remove the keyboard (Section 7.7).
6. Remove the microphone/display cable cover (Section 7.11).
7. Disconnect the touchpad cable from connector on the system board.

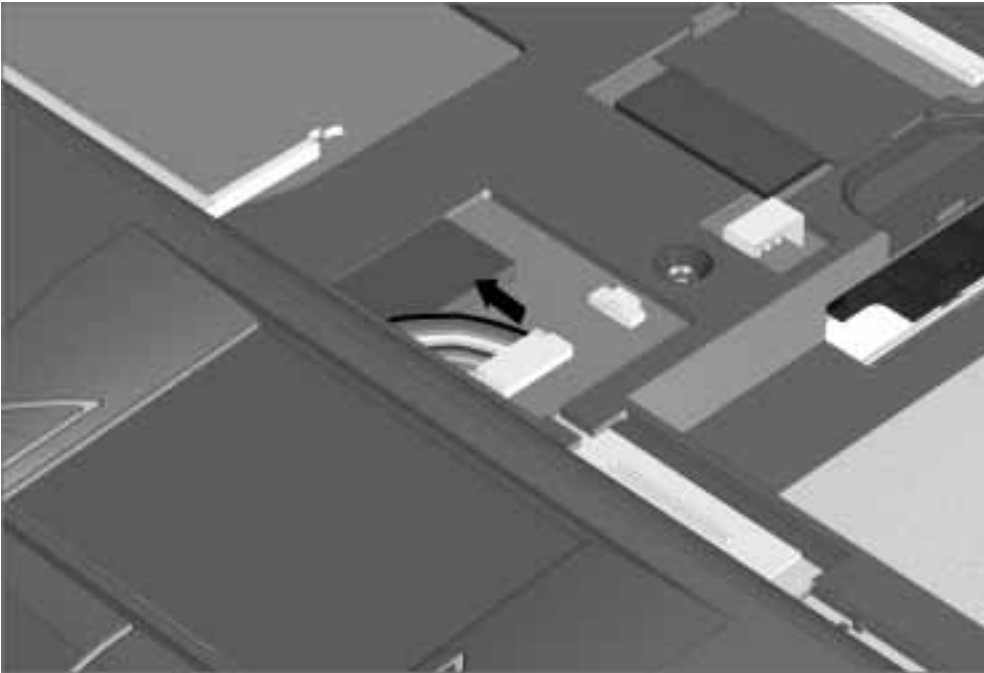

Figure 7-30. Disconnecting the Touchpad Connector from the System Board

-
7. Use the case utility tool to carefully pry up the top cover assembly from the base enclosure.

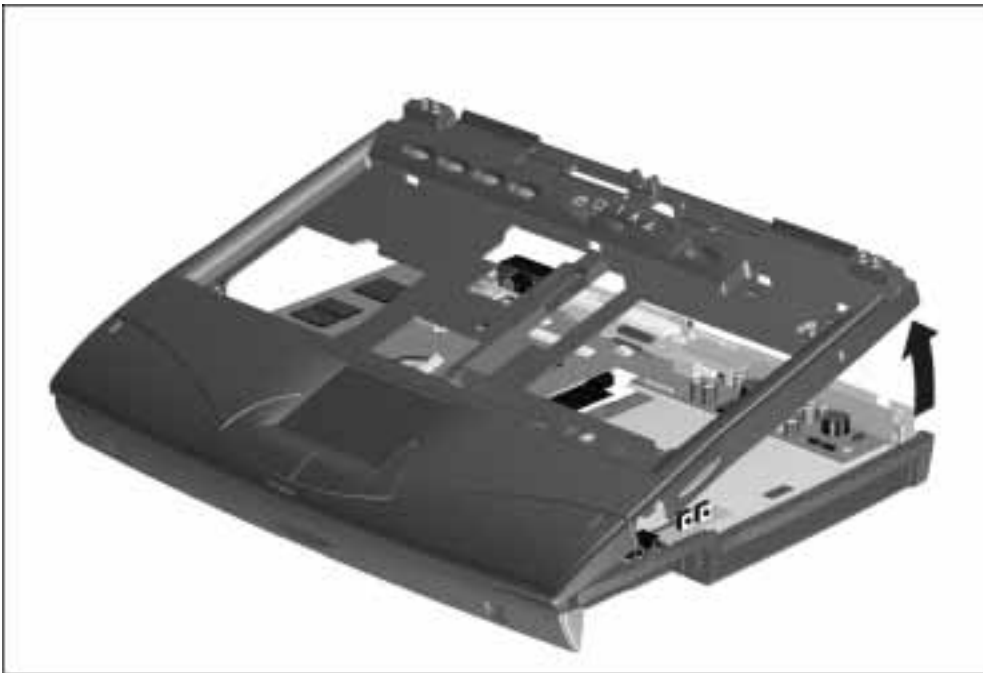





Figure 7-31. Removing the Top Cover Assembly

To replace the top cover assembly, reverse the steps.

.....

7.13.1 Power Button

To remove the power button from the top cover assembly, complete the following procedures.

1. Remove the top cover assembly (Section 7.13).
2. Squeeze inward on the power button retaining latches .
3. Press down to remove the power button  and tension spring .

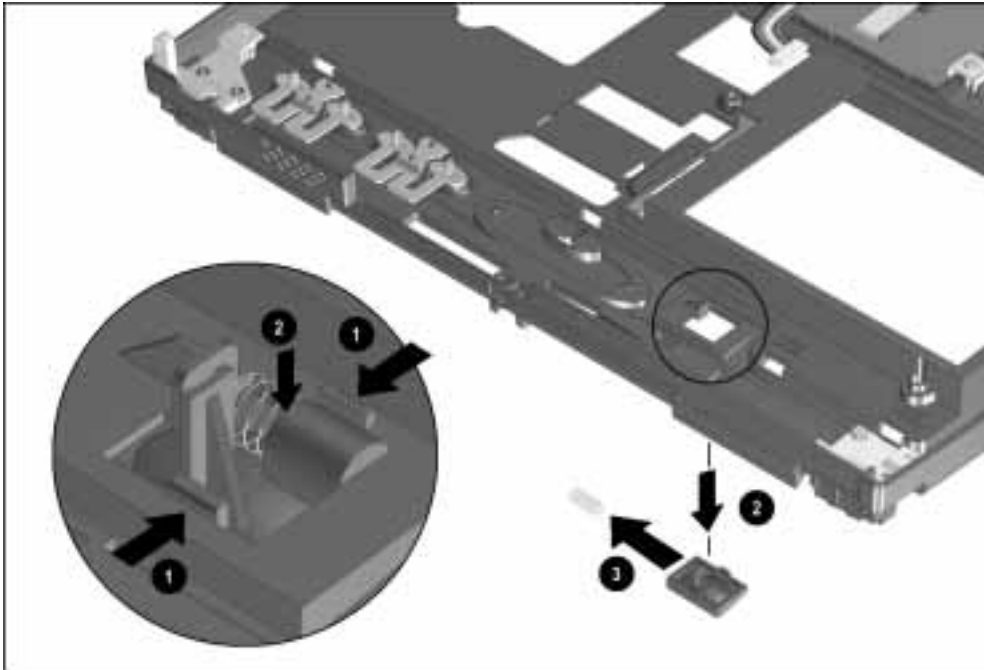





Figure 7-32. Removing the Power Button

To replace the power button, reverse the steps.

7.13.2 Suspend Button

To remove the Suspend button from the top cover assembly, complete the following procedures.

1. Remove the top cover assembly (Section 7.13).
2. Squeeze inward on the two Suspend button retaining latches .
3. Press down to remove the Suspend button  and tension spring .

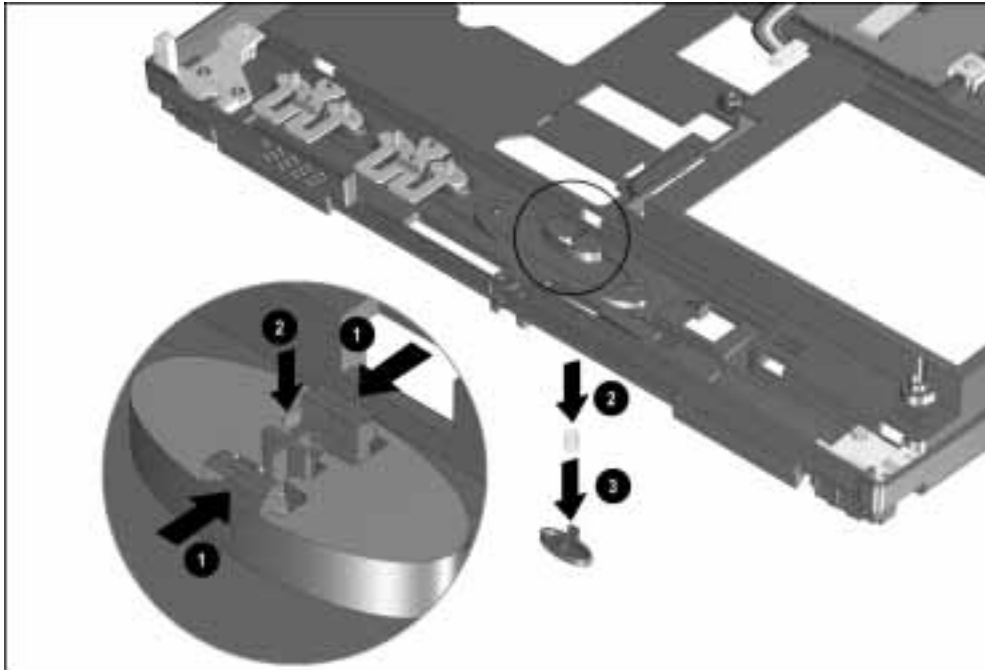

Figure 7-33. Removing the Suspend Button



To replace the Suspend button, reverse the steps.

.....

7.13.3 Left and Right Touchpad Buttons

To remove the touchpad buttons from the top cover assembly, complete the following procedures.

NOTE: Only the right touchpad button is shown in this illustration.

1. Remove the top cover assembly (Section 7.13).
2. Remove two touchpad board screws  and the touchpad board .

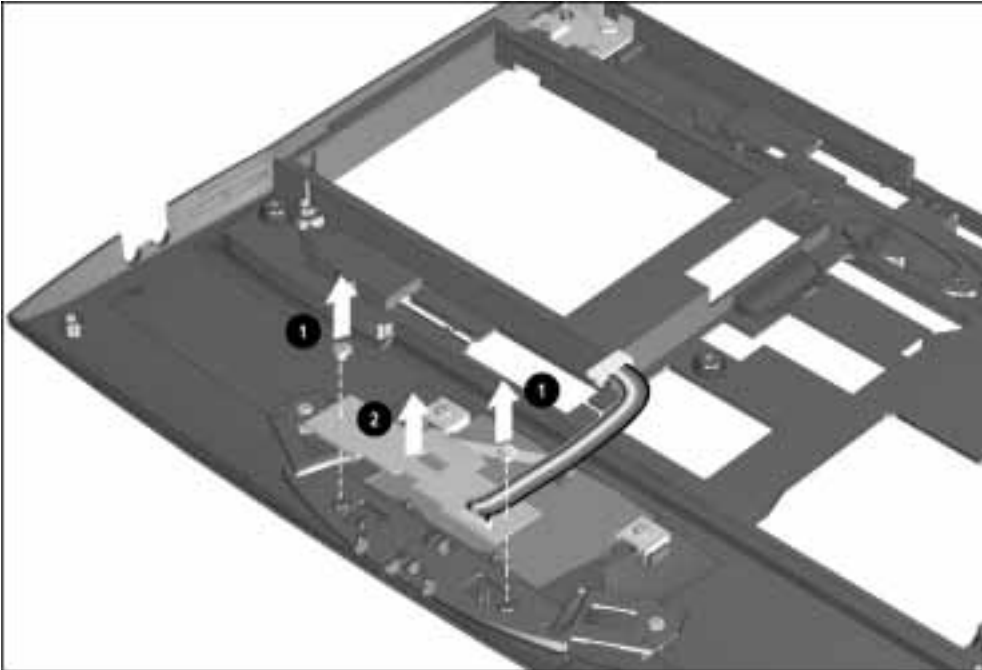





Figure 7-34. Removing the Touchpad Screws and Board

-
3. Remove the screw from the touchpad button .
 4. Press back  and downward  on the backside of the touchpad button to remove.

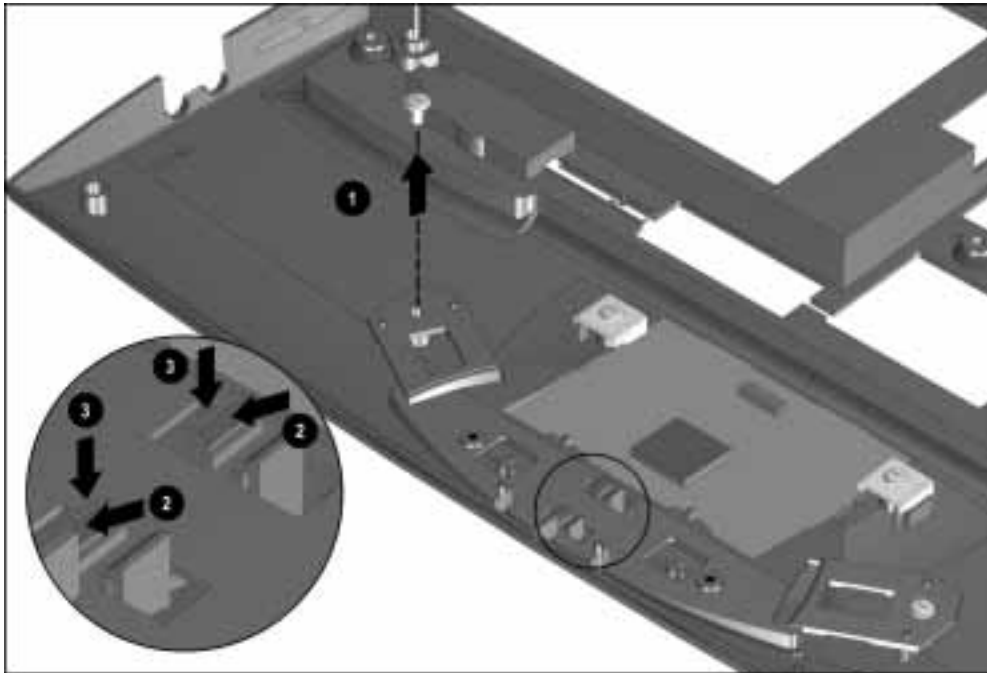

Figure 7-35. Removing the Touchpad Button

To replace the touchpad buttons, reverse the steps.

7.14 LED Status Panel

To remove the LED status panel board, complete the following procedures:

1. Disconnect the AC power and any external devices (Section 7.4.1).
2. Remove the battery pack (Section 7.4.3).
3. Remove the DualBay device (Section 7.4.4).
4. Remove any PC Cards (Section 7.4.5).
5. Remove the keyboard (Section 7.7).
6. Remove the microphone/display cable cover and microphone (Section 7.11).
7. Remove the clutch covers/display assembly (Section 7.12.1).
8. Remove the top cover assembly (Section 7.13).
9. Disconnect the LED status panel board from the system board.

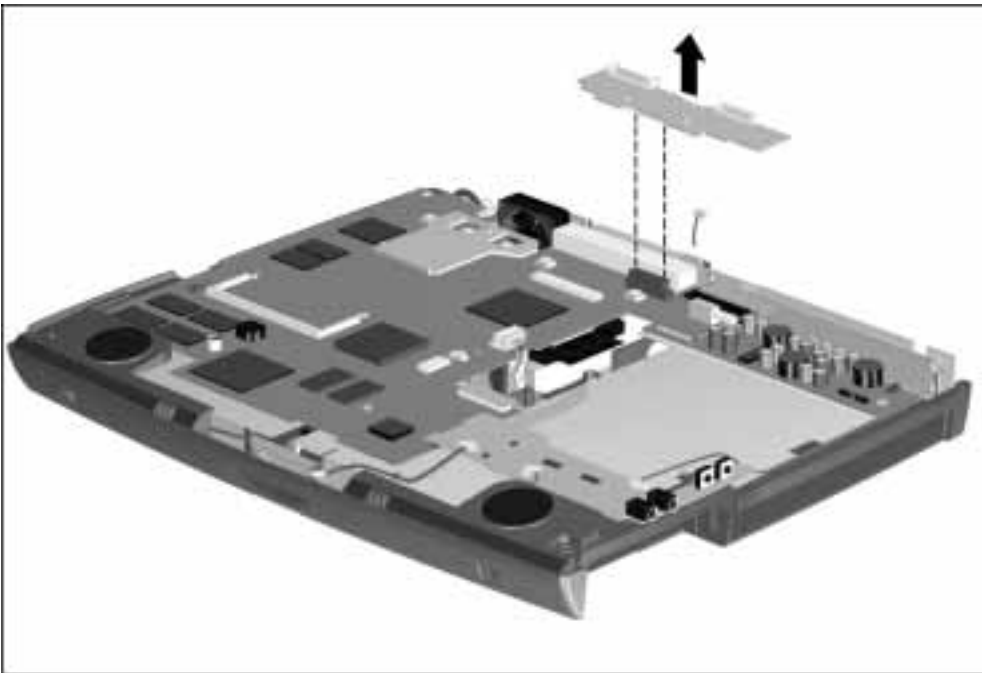

Figure 7-36. Removing the LED Status Panel Board

To replace the LED status panel, reverse the steps.

7.15 Audio Board, Speakers, and Audio Cable



CAUTION: The Audio board is secured by a short, T-8 screw. Do not use the long, T-8 screw to secure the Audio board. Use of the long screw may damage the system board.

To remove the audio board, speakers, and audio cable, complete the following procedures:

1. Disconnect the AC power and any external devices (Section 7.4.1).
2. Remove the battery pack (Section 7.4.3).
3. Remove the DualBay device (Section 7.4.4).
4. Remove any PC Cards (Section 7.4.5).
5. Remove the keyboard (Section 7.7).
6. Remove the microphone/display cable cover and microphone (Section 7.11).
7. Remove the clutch covers/display assembly (Section 7.12.1).
8. Remove the LED status panel board (Section 7.14).
9. Remove the screw from the audio board.

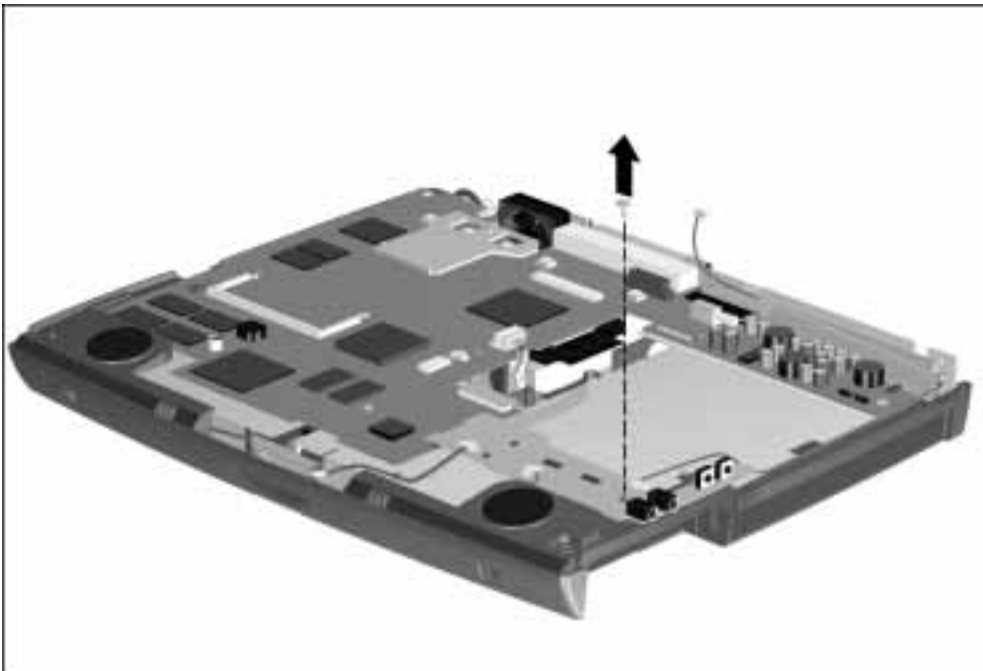









Figure 7-37. Removing the Screw from the Audio Board

10. Disconnect the audio cable from the system board  and remove  the cable.
11. Disconnect the right  and left  speakers.
12. Remove the right  and left  speakers.
13. Remove the audio board from the base enclosure .

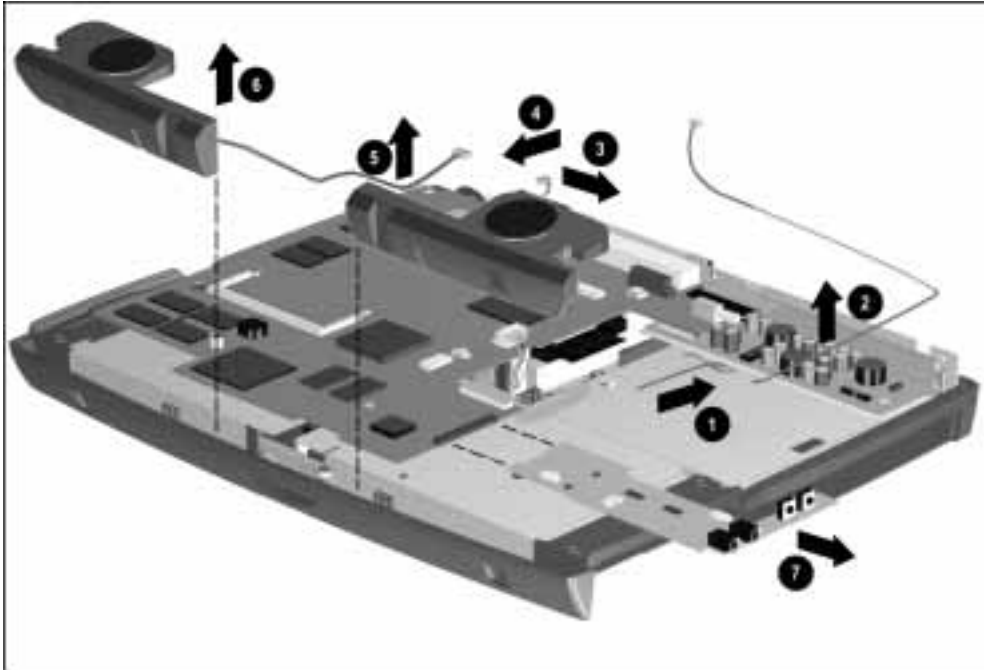

Figure 7-38. Removing the Audio Cable, Speakers, and Audio Board

To replace the audio cable, speakers, or audio board, reverse the steps.

7.16 DC-DC Converter



CAUTION: The DC-DC Converter board is secured by a short, T-8 screw. Do not use the long, T-8 screw to secure the DC-DC Converter board. Use of the long screw may damage the system board.

To remove the DC-DC converter, complete the following procedures:

1. Disconnect the AC power and any external devices (Section 7.4.1).
2. Remove the battery pack (Section 7.4.3).
3. Remove the DualBay device (Section 7.4.4).
4. Remove any PC Cards (Section 7.4.5).
5. Remove the keyboard (Section 7.7).
6. Remove the microphone/display cable cover and microphone (Section 7.11).
7. Remove the clutch covers/display assembly (Section 7.12.1).
8. Remove the top cover assembly (Section 7.13).

9. Remove the screw that secures the DC-DC converter to the base enclosure .

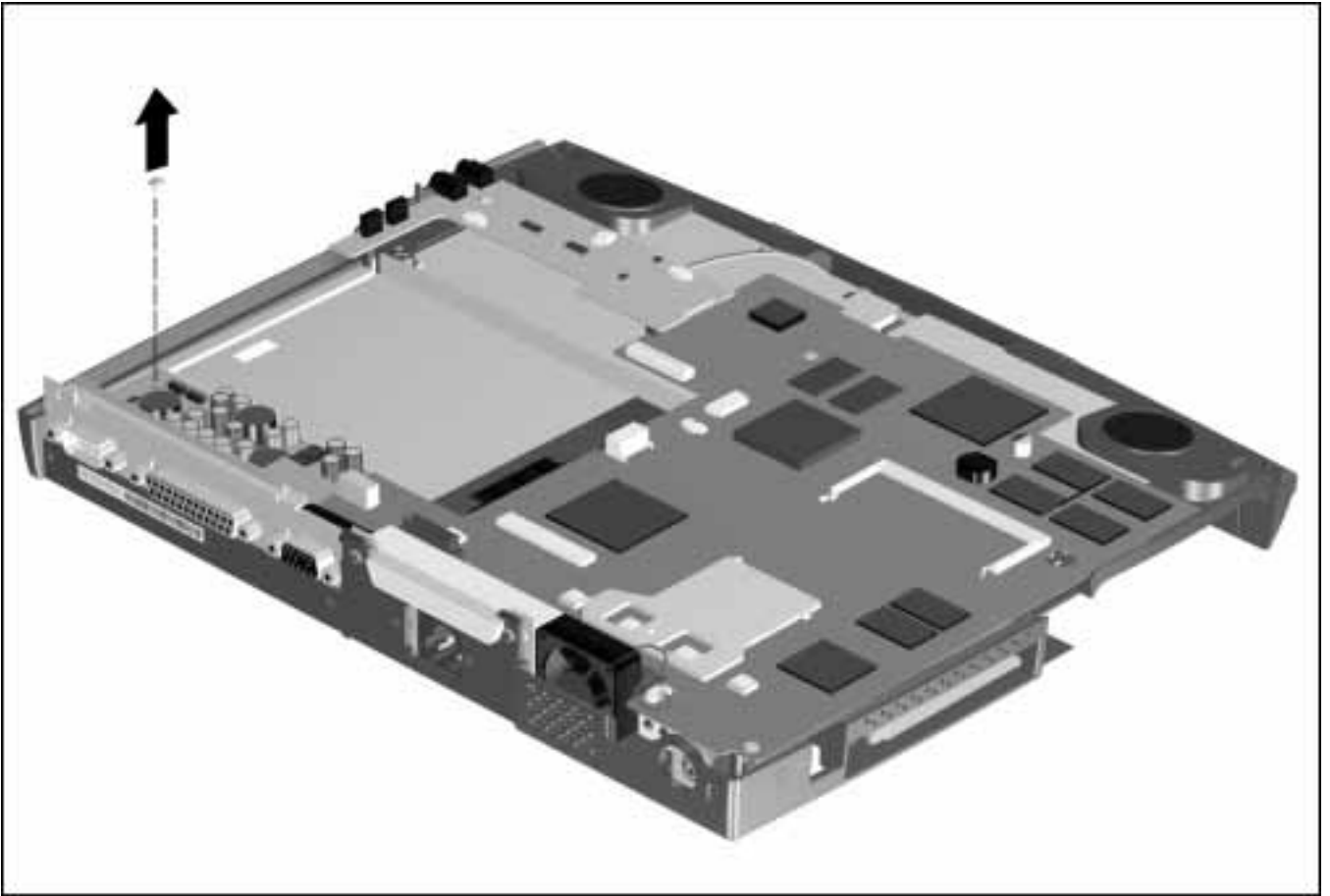

Figure 7-39. Removing the DC-DC Converter Screw

.....

10. Disconnect the DC-DC converter from the system board.

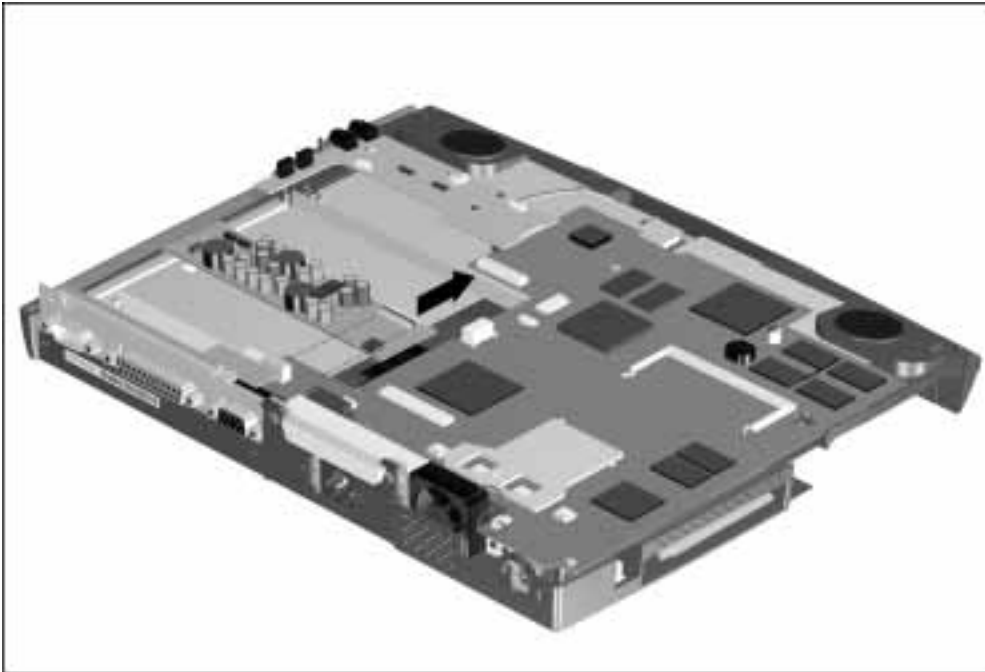



Figure 7-40. Disconnecting the DC-DC Converter

-
11. Pull the DC-DC Converter away from the plastic tab separating the DC-DC Converter from the I/O fixture connector .
 12. Remove the DC-DC Converter .

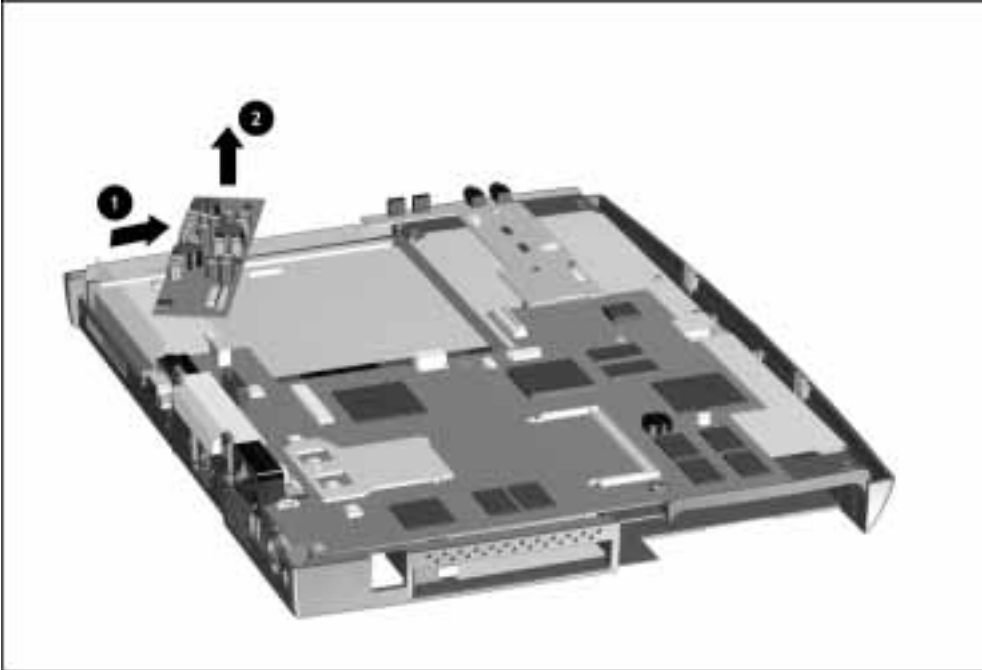



Figure 7-41. Removing the DC-DC Converter

To replace the DC-DC converter, reverse the steps.

7.17 Fan

To remove the fan, complete the following procedures:

1. Disconnect the AC power and any external devices (Section 7.4.1).
2. Remove the battery pack (Section 7.4.3).
3. Remove the DualBay device (Section 7.4.4).
4. Remove any PC Cards (Section 7.4.5).
5. Remove the keyboard (Section 7.7).
6. Remove the microphone/display cable cover and microphone (Section 7.11).
8. Remove the clutch covers/display assembly (Section 7.12.1).
9. Remove the top cover assembly (Section 7.13).

10. Disconnect the fan from the system board.
11. Remove the fan from the base enclosure .

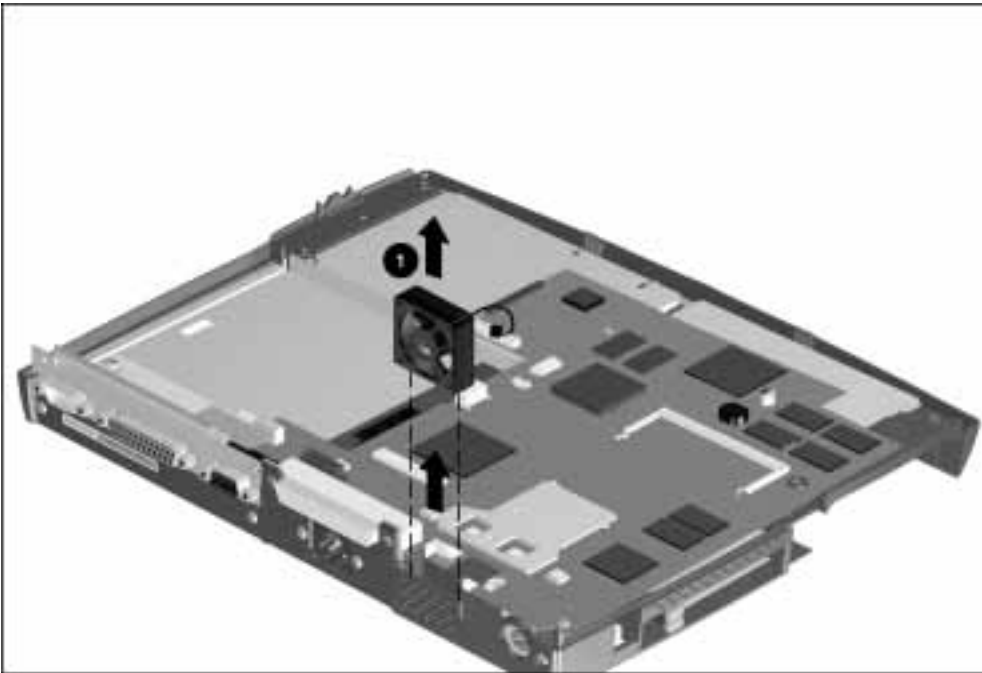

Figure 7-42. Removing the Fan

Reverse the procedure to install the fan.

IMPORTANT: When installing the fan, orient the fan so that the label and airflow direction arrow point to the rear of the computer.

7.18 I/O Fixture Connector

To remove the I/O fixture connector, complete the following procedures.

1. Disconnect the AC power and any external devices (Section 7.4.1).
2. Remove the battery pack (Section 7.4.3).
3. Remove the DualBay device (Section 7.4.4).
4. Remove any PC Cards (Section 7.4.5).
5. Remove the keyboard (Section 7.7).
6. Remove the microphone/display cable cover (Section 7.11).
7. Remove the clutch covers/display assembly (Section 7.12.1).
8. Remove the top cover assembly (Section 7.13).
9. Remove the LED status panel board (Section 7.14).
10. Remove the Audio board, audio cables, and speakers (Section 7.15).
11. Remove the fan (Section 7.17).
12. Remove four screws securing the I/O fixture to the rear of the computer.

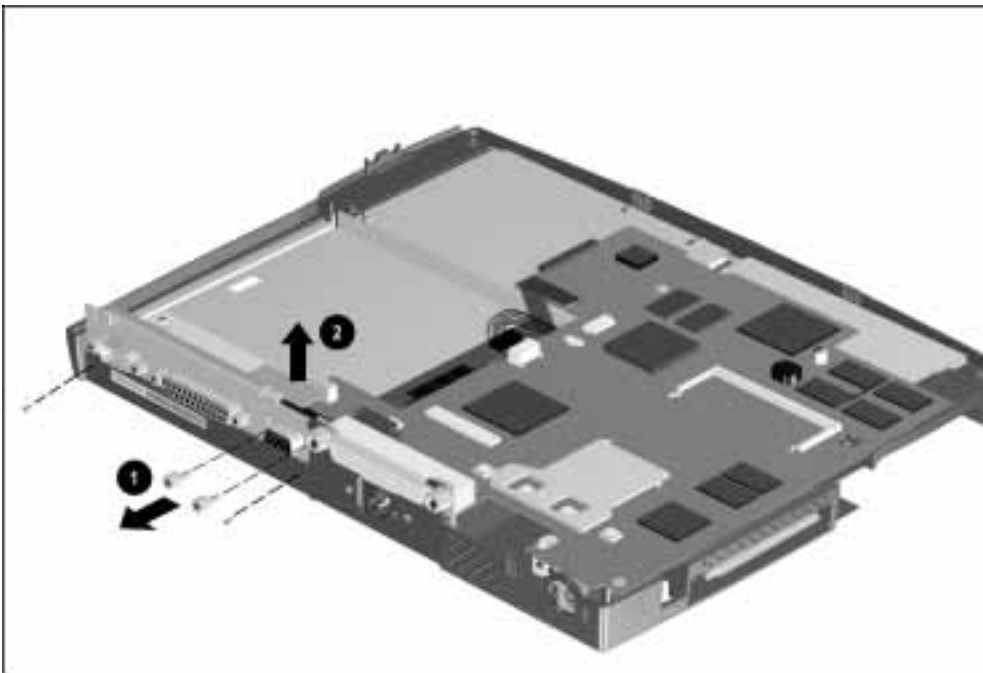

Figure 7-43. Removing the Screws from the I/O Fixture Connector

.....

13. Remove the I/O fixture connector.

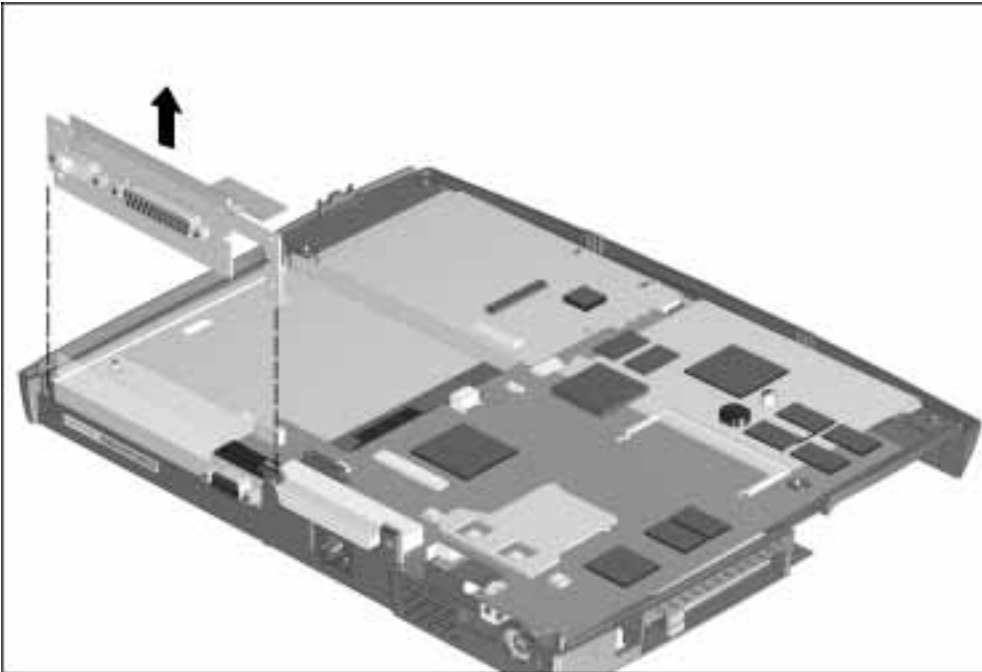





Figure 7-44. Removing the I/O Fixture Connector

To replace the I/O fixture connector, reverse the steps.

7.19 System Board

To remove the system board, complete the following procedures:

1. Disconnect the AC power and any external devices (Section 7.4.1).
2. Remove the battery pack (Section 7.4.3).
3. Remove the DualBay device (Section 7.4.4).
4. Remove any PC Cards (Section 7.4.5).
5. Remove the top cover assembly (Section 7.1.3).
6. Remove the I/O fixture connector (Section 7.18).
7. Remove the screws securing the system board to base enclosure .
8. Disconnect the CD-ROM cable .
9. Disconnect the AC power .
10. Remove the two screws from the rear of the computer that secure the system board to the base enclosure .

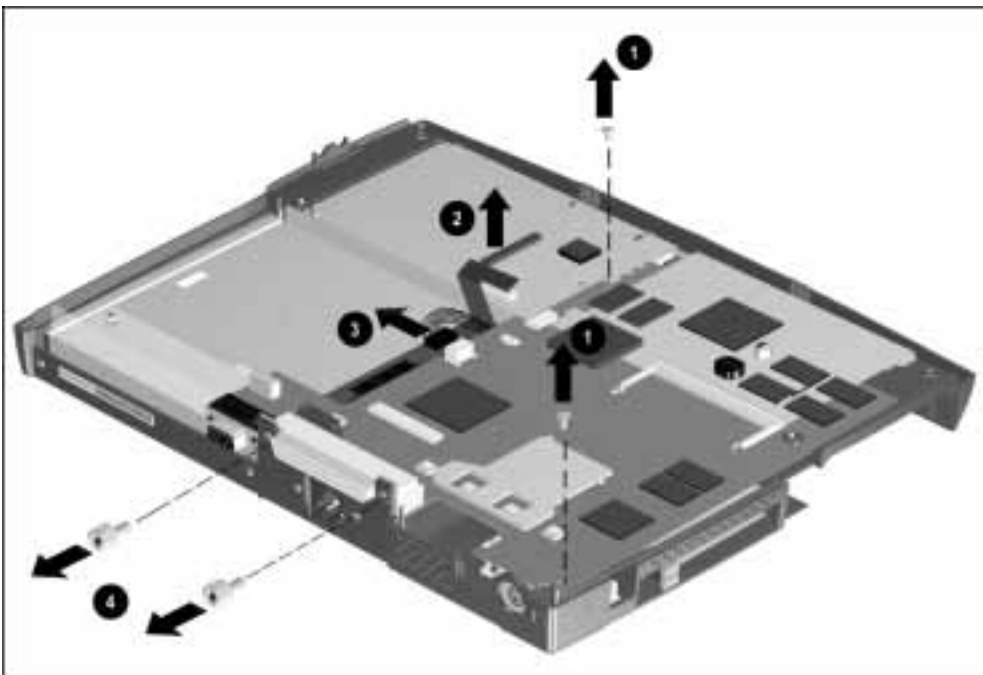



Figure 7-45. Disconnecting the System Board

-
12. Tilt the system board up .
 13. Lift the system board away from the base enclosure .

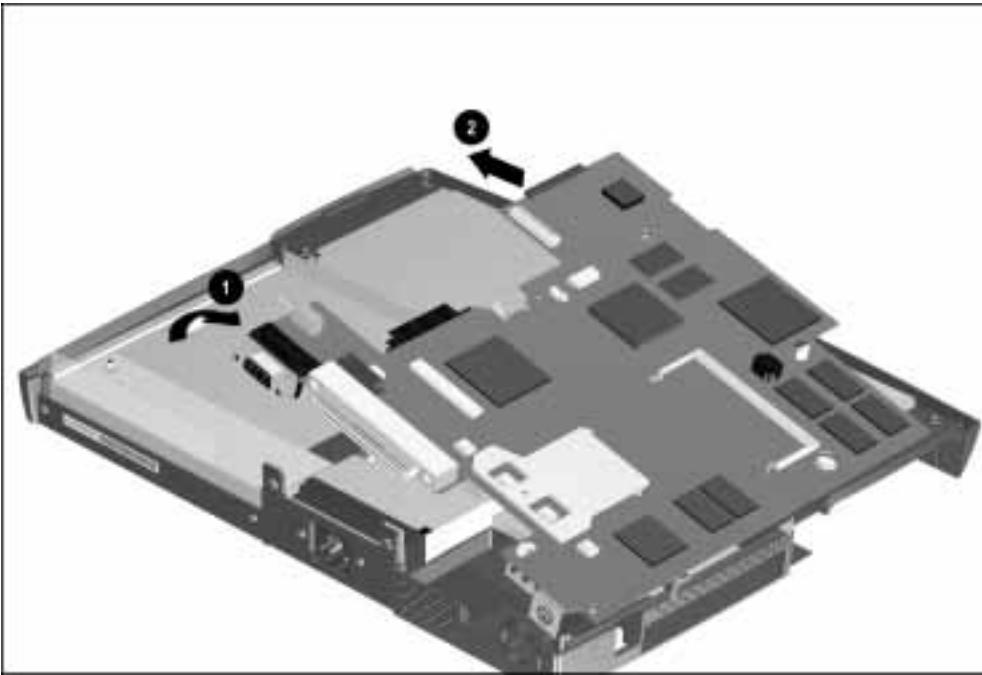





Figure 7-46. Removing the System Board

To replace the system board, reverse the steps.

NOTE: Before replacing the system board, the PC Card eject levers must be in the forward position. See Section 7.4.5 for proper positioning of the PC Card eject levers.

7.20 AC Power

To remove the AC power, complete the following procedures:

1. Disconnect the AC power and any external devices (Section 7.4.1).
2. Remove the battery pack (Section 7.4.3).
3. Remove the DualBay device (Section 7.4.4).
4. Remove any PC Cards (Section 7.4.5)
5. Remove the top cover assembly (Section 7.13).
6. Remove the system board (Section 7.19).
7. Remove two screws from the rear of the base enclosure .
8. Remove two screws from the base enclosure .
9. Lift out the AC power .

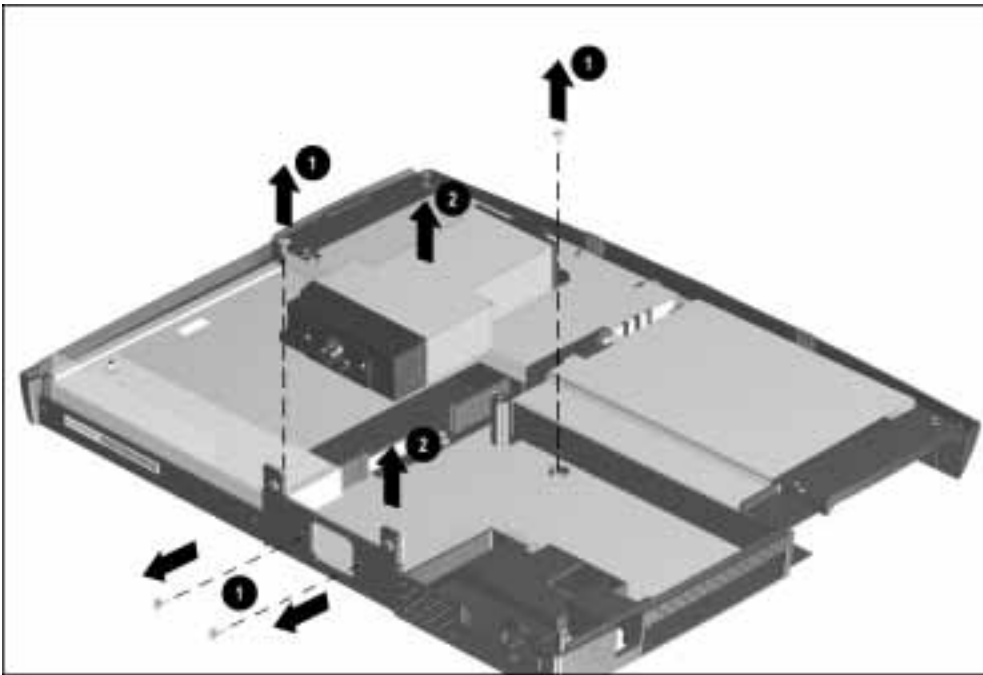

Figure 7-47. Removing the Integrated AC Power

7.21 External Computer Components

This section describes the removal and replacement procedures that do not require access to the internal components of the computer. This includes:

- Computer logo
- Computer feet

7.21.1 Computer Logo

The computer logo is on the outside of the display assembly and may be replaced if damaged. To replace the logo, complete the following steps:

1. Use a small, sharp, flat-bladed screwdriver to pry up the existing logo.
2. Clean the area with a clean dry cloth.
3. Apply the new logo.

7.21.2 Computer Feet

There are four locations where the computer feet may be applied. To replace the computer feet, complete the following steps:

1. Peel the old foot from the computer. Use a razor blade if needed to lift a corner of the foot free from the base cover.
2. Clean the area where the new foot is to be applied with a clean dry cloth.
3. Install the new foot, pressing it firmly into place.

Upgrade Procedures for the Convenience Base

This chapter presents the upgrade procedures for the convenience base with Ethernet models. If a hardware failure is suspected, run the diagnostic test in Chapter 3. If hardware failure, other than the network upgrade card is determined, follow the recommended procedures to replace the convenience base.

8.1 Serial Number

The convenience base serial number should be provided to Compaq when requesting information or ordering spare parts. The serial number is displayed on the rear of the convenience base.

8.2 Preliminary Procedure



CAUTION: Electrostatic discharge (ESD) can damage electronic components. Before beginning this procedure, ensure that you are properly grounded.

Before beginning this procedure:

1. Unplug the power cord from the convenience base and the power source.
2. Undock the computer, if necessary (Section 7.4.2).

.....

8.2.1 Installing the Optional 100BaseT Ethernet Network Module

To install the 100BaseT module, complete the following procedures:

1. Turn the convenience base bottomsides up and remove seven screws from the lower base plastic housing.

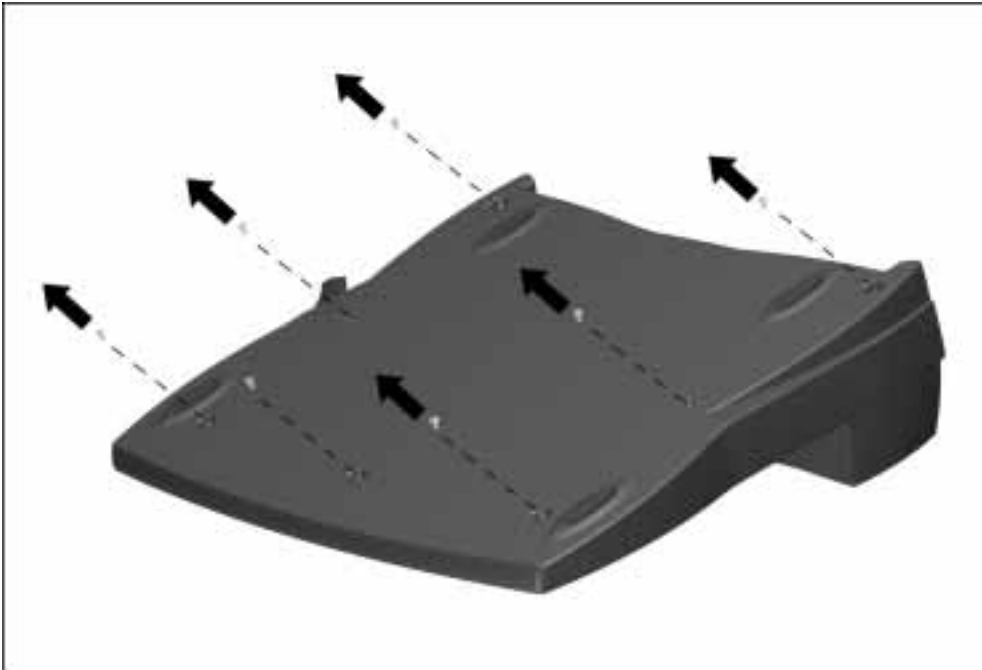

Figure 8-1. Removing the Screws from the Lower Base Plastic Housing

.....

2. Remove the base plastic housing.



Figure 8-2. Removing the Base Plastic Housing

.....

3. Remove two screws from the LAN card access shield.

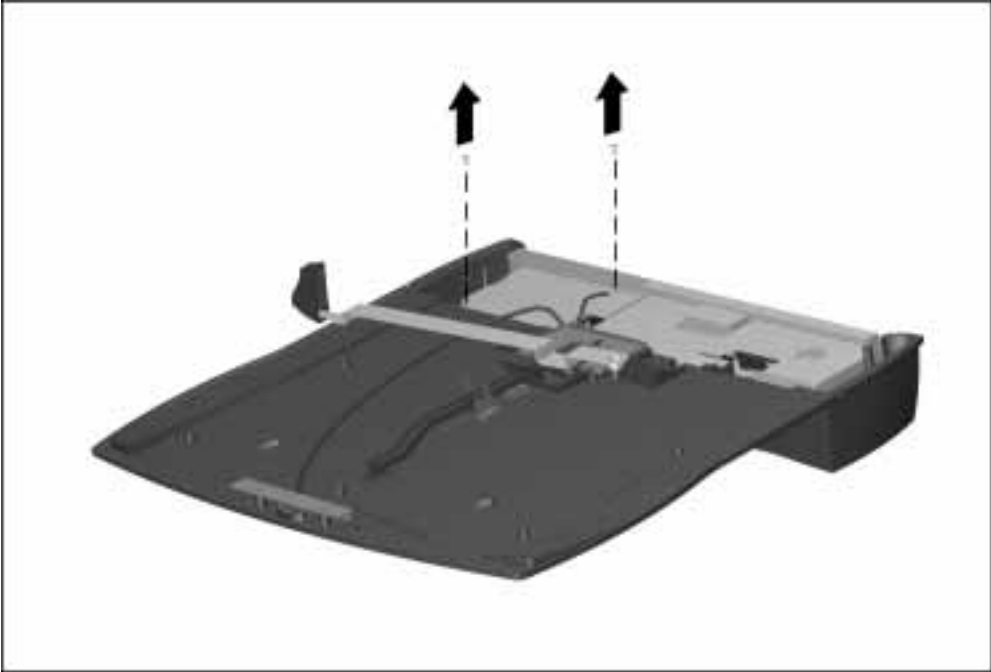

Figure 8-3. Removing the Screws from the LAN Card Access Shield

.....

4. Remove the LAN card access shield.

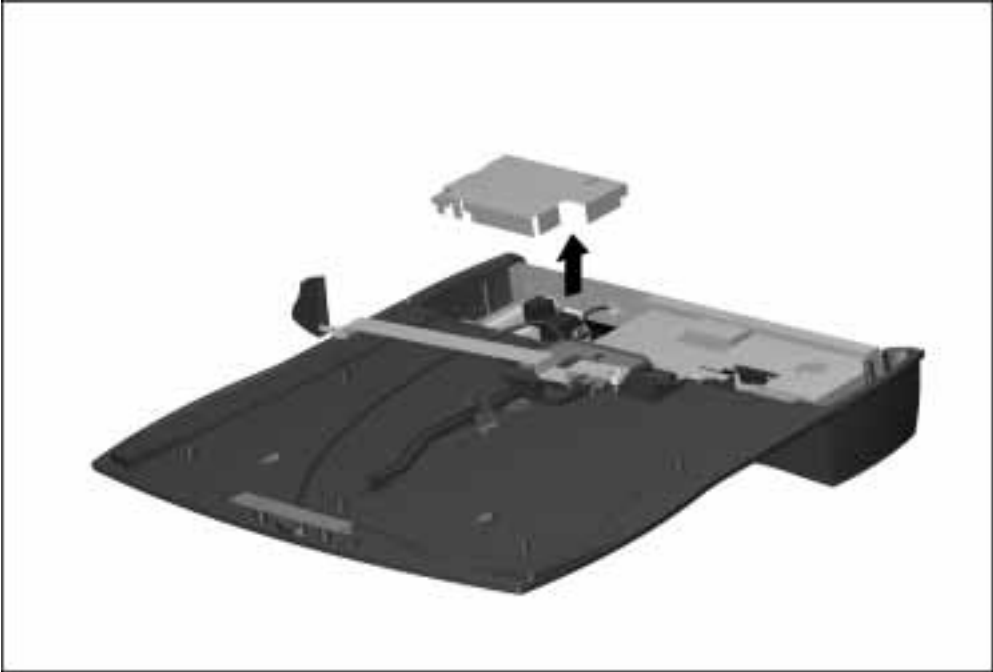

Figure 8-4. Removing the LAN Card Access Shield

.....

5. Remove the 10BaseT module.

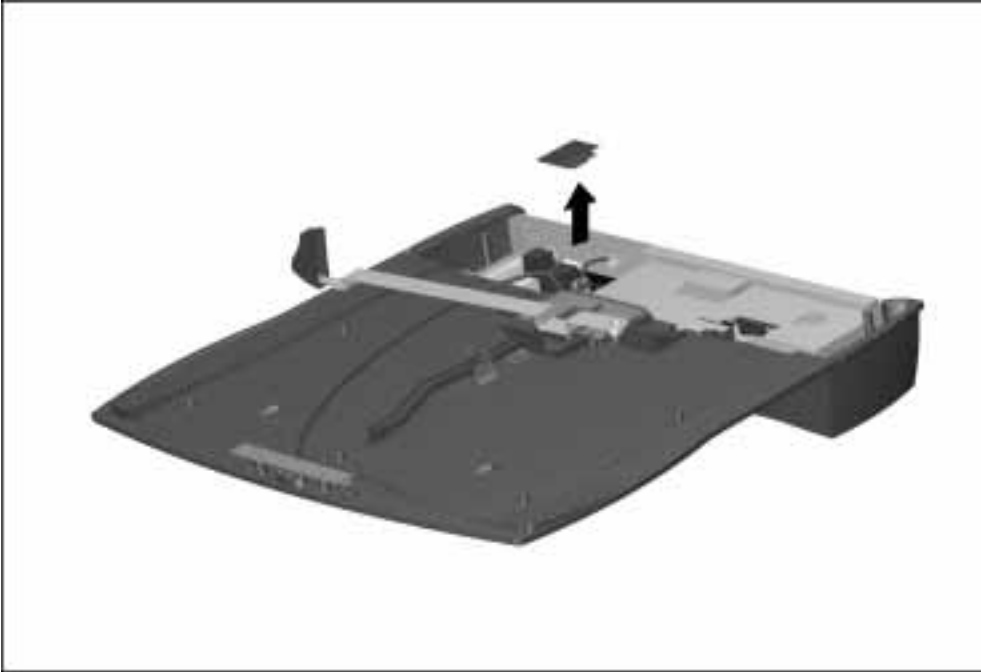

Figure 8-5. Removing the 10BaseT

.....

6. Install the 100BaseT module.

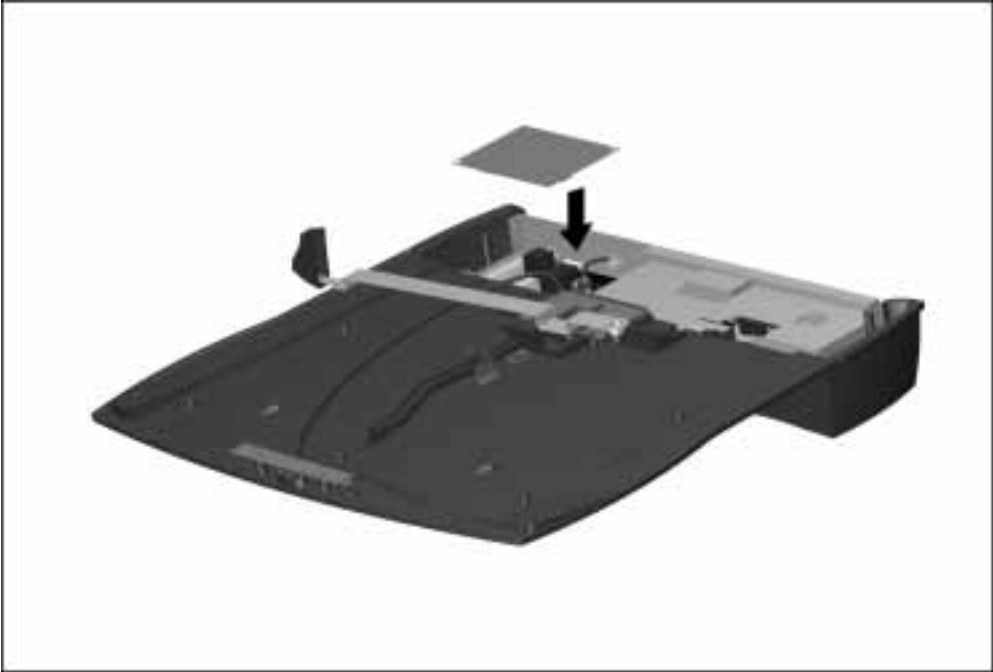

Figure 8-6. Installing the 100BaseT module

.....

7. Replace the LAN access shield and screws.

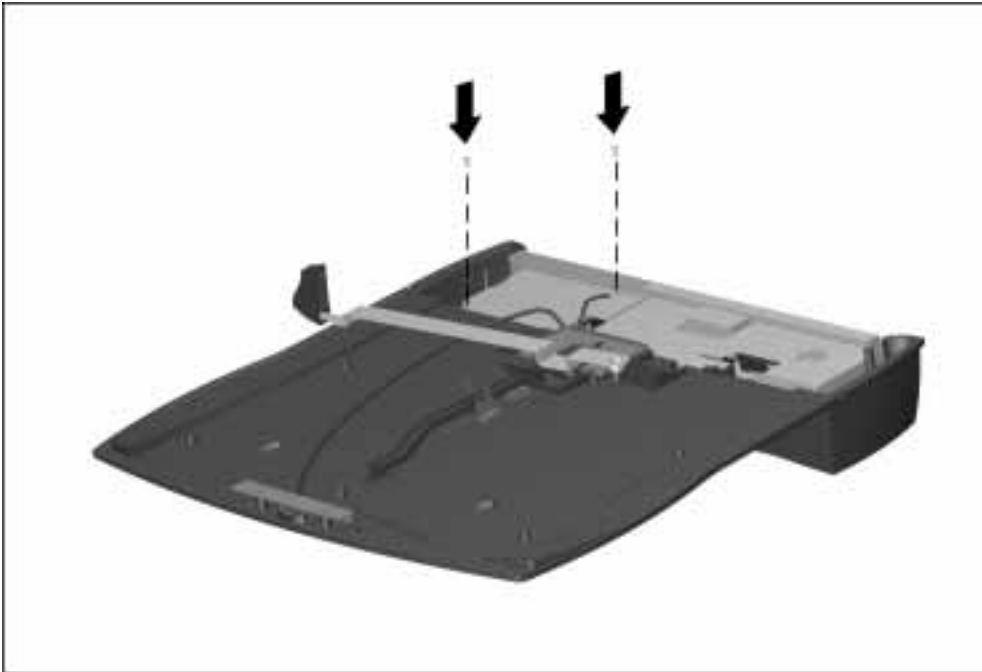

Figure 8-7. Reinstalling the LAN card Access Shield and screws

.....

8. Reinstall the screws in the base plastic housing.

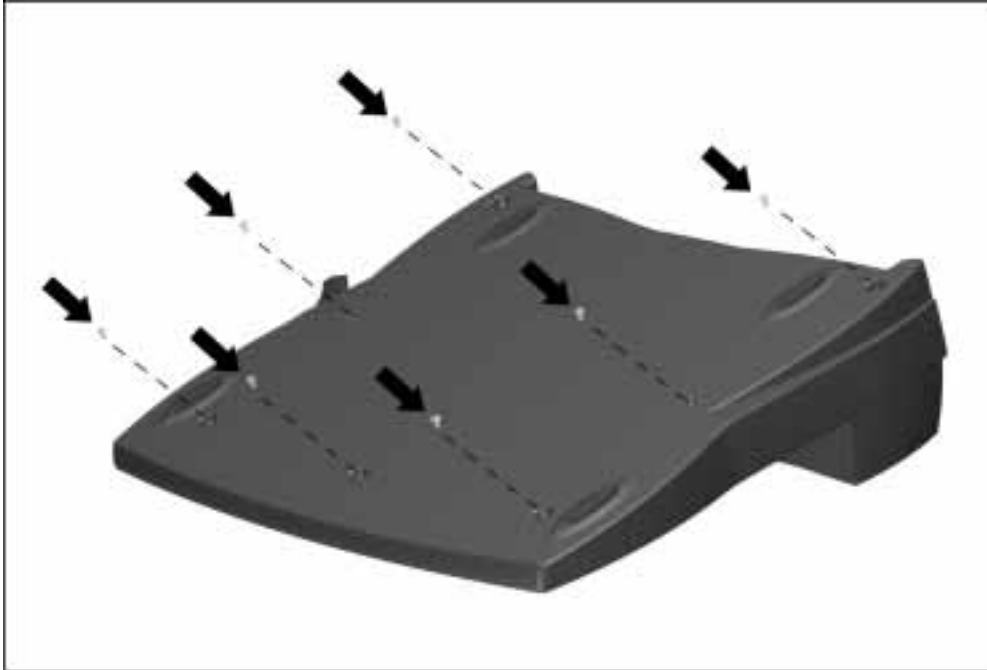

Figure 8-8. Reinstalling the Screws in the Base Plastic Housing

NOTE: Return the 10BaseT module to the customer.

Specifications

This chapter provides physical and performance specifications for the following:

- Computer
- Displays
- Hard drives
- Diskette drive
- CD-ROM drive
- Battery packs
- Convenience Base
- External power sources

The chapter also includes:

- System interrupts
- System DMA
- System I/O address
- System memory map

9.1 Computer

Table 9-1

	U.S.	Metric
Dimensions		
Height	2.09 in	53 mm
Depth	10.65 in	245 mm
Width	12.24 in	311 mm
Weight		
With battery and optional CD-ROM	7.3 lbs	3.142 kg
Standalone (Battery) Power Requirements		
Nominal Operating Voltage (Li-Ion)	14.2 VDC	14.2 VDC
Nominal Operating Voltage (NiMH)	9.6v	9.6v
Maximum Operating Power	35.0 W	35.0 W
Peak Operating Power	40.0 W	40.0 W
Integrated AC Power Requirements		
Operating Voltage	100 to 240 VAC RMS	100 to 240 VAC RMS
Operating Current	1.10 A RMS	1.10 A RMS
Operating Frequency Range	50 to 60 Hz AC	50 to 60 Hz AC
Maximum Transient	4/50 kV	4/50 kV
Automobile Adapter DC Input Requirements		
Operating Voltage	11 to 16 VDC	11 to 16 VDC
Operating Power	85.0 W	85.0 W
Temperature		
Operating	5 to 95°F	10 to 40°C
Nonoperating	-4 to 140°F	-30 to 60°C
Relative Humidity (noncondensing)		
Operating	10 to 90%	10 to 90%
Nonoperating ($t_w = 38.7^\circ\text{C max}$)	5 to 90%	5 to 90%
Altitude		
Operating	0 to 10,000 ft	0 to 3.15 km
Nonoperating	0 to 30,000 ft	0 to 10.14 km
Shock		
Operating	10 G, 11 ms, half sine	
Non operating	240 G, 2 ms, half sine	
Vibration		
Operating	0.55 G, 0.25 Oct/Min sweep rate	
Nonoperating	1.5 G, 0.5 Oct/Min sweep rate	

NOTE: Applicable product safety standards specify thermal limits for plastic surfaces. The Compaq Armada operates well within this range of temperatures.

.....

9.2 Displays

Table 9-2
11.3-Inch CSTN, SVGA Display

	U.S.	Metric
Dimensions		
Height	6.77 in	171.88 mm
Width	10.02 in	2210.18 mm
Number of Colors	262 K	
Contrast Ratio	22:1	
Pixel Resolution		
Pitch	0.29 × 0.29 mm	
Format	800 × 600	
Configuration	RGB Stripe	
Backlight	Edge Lit	
Character Display	80 × 25	

Table 9-3
12.1-Inch CTFT, SVGA Display

	U.S.	Metric
Dimensions		
Height	10.05 in	1710.1 mm
Width	10.40 in	238.8 mm
Number of Colors	262 K	
Contrast Ratio	100:1	
Pixel Resolution		
Pitch	0.29 x 0.29 mm	
Format	800 x 600	
Configuration	RGB Stripe	
Backlight	Edge Lit	
Character Display	80 × 25	

9.3 Hard Drives

Table 9-4

Standard Model Configurations	1.0-GB	1.4-GB
Formatted Capacity per Drive (MB)		
Physical	1088.1	1.40
Logical	1085.8	814.3
Drive Type	65	65
Drive Height		
With drive frame (mm)	12.7	12.7
Drive Size		
Inches	2.5 x 0.5	2.5 x 0.5
Millimeters	102 x 75	102 x 75
Transfer Rate		
Media (Mb/s)	29.0 to 54.0	38.0 to 54.0
Interface (Mb/s)	16.6	16.6
Sector Interleave	1:1	1:1
Typical Seek Time (Including setting)		
Single Track (ms)	3	3
Average (ms)	13	13
Full Stroke (ms)	24	24
Disk Rotational Speed (RPM)	4635	4200
Physical Configuration		
Cylinders	3915	3915
Data Heads	6	6
Sectors/Track	90-180	90-180
Bytes/Sector	512	512
Logical Configuration		
Cylinders	2100	2796
Heads	16	16
Sectors per Track	63	63
Bytes per Sector	512	512
Buffers Size (KB)	128	128

.....

9.4 Diskette Drive

Diskette size	3.5-inch
High density	1.44-MB/1.2-MB
Low density	720 KB
Light	None
Height	0.43-in (11 mm)
Bytes per sector	512
Sectors per Track	
High density	18 (1.44-MB)/15 (1.2-MB)
Low density	9
Tracks per Side	
High density	80 (1.44-MB)/80 (1.2-MB)
Low density	80
Read/Write heads	2
Average Seek Times	
Track-to-Track (high/low)	3 ms/6 ms
Average (high/low)	94 ms/174 ms
Settling Time	15 ms
Latency Average	100 ms

9.5 CD-ROM Drive

Table 9-6

Applicable Disc	CD-ROM mode 1, mode 2 CD-Digital Audio CD-XA mode 2 (Form 1, Form 2) CD-I mode 2 (Form1, Form 2) CD-I Ready CD-Bridge CD-WO (fixed/variable packets) Photo CD (singlemultisession)
Center Hole Diameter	15 mm
Disc Diameter	12 cm, 8 cm
Disc Thickness	1.2 mm
Track Pitch	1.6 μ m
Laser	
Beam Divergence	53.5 \pm 1.5 degrees
Output Power	0.24 \pm 0.1 mw
Type	Semiconductor Laser GaAlAs
Wave Length	780 nm \pm 25 nm
Access time	
Random	<350 ms
Full Stroke	<750 ms
Audio output level	
Line Out	0.7 Vrms
Headphone	None
Cache buffer	128 KB
Data transfer rate	
Sustained, 10x	1500 KB/sec
Sustained, single	150 KB/sec
Burst	8.3 MB/sec
Startup Time	<8 seconds typical
Capacity	
Mode 1, 12 cm	550 MB
Mode 2, 12 cm	640 MB
8 cm	180 MB

9.6 Battery Packs

Table 9-7
Lithium Ion Modular Battery Pack

	U.S.	Metric
Dimensions		
Height	0.82 in	20.8 mm
Length	5.8 in	147.32 mm
Width	3.2 in	81.3 mm
Weight		
	1.2 lb	5.5 g
Electrical		
Voltage	14.4 V	
Amp-hour capacity	2.8 Ah	
Watt-hour capacity	40.0 Wh	
Environmental Requirements		
Operating temperatures	50°F to 104°F	10°C to 40°C
Nonoperating temperatures	-12°F to 140°F	-30°C to 60°C

Table 9-8
Nickel Metal Hydride Battery Pack

	U.S.	Metric
Dimensions		
Height	0.82 in	20.8 mm
Length	5.8 in	147.32 mm
Width	3.2 in	81.3 mm
Weight		
	1.2 lb	5.5 g
Electrical		
Voltage	9.6 V	
Amp-hour capacity	4.0 Ah	
Watt-hour capacity	36 Wh	
Environmental Requirements		
Operating temperatures	50°F to 104°F	10°C to 40°C
Nonoperating temperatures	-12°F to 140°F	-30°C to 60°C

9.7 Convenience Base

Table 9-9		
	U.S.	Metric
Dimensions		
Height	4.9 in	12.46 cm
Height w/Monitor Stand	5.2 in	13.208 cm
Length	14.7in	37.34 cm
Width	14.2 in	36.07 cm
Weight		
Expansion Base	4.25 lbs	1.93 kg
Expansion Base w/Monitor Stand	5.8 lbs	2.63 kg
Power Supply (Input)		
Operating Voltage	100 to 240 VAC	
Operating Current	1.10 Amp Maximum	
Rated Voltage	100 to 240 VAC	
Rated Current	1.0 Amp Maximum	
Line Frequency	47 to 63 Hz.	
Temperature		
Operating	50 to 95°F	10 to 35°C
Storage	-4 to 140°F	20 to 60°C
Relative Humidity		
Operating	10 to 90%	
Storage	5 to 95%	
Altitude		
Operating	10,000 ft	3.15 km
Nonoperating	30,000 ft	10.14 km
Shock		
Operating	10 G, 11 ms, half sine	
Nonoperating	140 G, 2 ms, half sine	
Vibration		
Operating	0.25 G, 5 to 500 Hz, 0.5 octave/min sweep rate	
Nonoperating	1.0 G, 5 to 500 Hz, 0.5 octave/min sweep rate	

9.8 External Power Supplies

The automobile adapter allows the computer to be used in an automobile without a drain on the computer's batteries.

Table 9-10 Automobile Adapter		
	U.S.	Metric
Dimensions		
Height	1.42 in	36 mm
Width	2.83 in	72 mm
Length	4.84 in	123 mm
Weight	0.88 lb	400 gm
Input Cord Length	310.4 in	1.0 m
Power Supply (Input)		
Nominal Voltage	13.8 VDC	
Operating Voltage	10.5 - 14.8 VDC	
Maximum Voltage	16.0 VDC	
Input Fuse Protection	8.0 A	
Power Supply (Output)		
Nominal Voltage	120 VAC	
Load Regulated Voltage	108 - 125 VAC	
Line Regulated Voltage	105 to 125 VAC	
Output Frequency	60 Hz +/- 3 Hz	
Output Overload Protection	150W @ 2 sec.	
Temperature		
Operating	32 to 104°F	0 to 40°C
Nonoperating	-4 to 140°F	-20 to 60°C
Relative Humidity		
Operating	10 to 90%	
Nonoperating	5 to 95%	

.....

The external battery charger controls the output voltage generated by AC Power.

Table 9-11
External Battery Charger

	U.S.	Metric
Dimensions		
Height	1.57 in	40 mm
Width	5.25 in	133 mm
Length	9.4 in	239 mm
Weight	1.1 lb	4.95 gm
Power Supply (Input)		
Nominal Voltage	+18.5 +/- 0.25 VDC	
Current	40 to 42 W	
Power Supply (Output)		
Nominal Voltage	+18.5 +/- 0.25 VDC	
Current	40 to 42 W	
Temperature		
Operating	41 to 104°F	5 to 40°C
Nonoperating	-4 to 185°F	-20 to +85°C
Relative Humidity		
Operating	10 to 95%	
Nonoperating	10 to 95%	

.....

9.9 System Interrupts

Table 9-12

Hardware IRQ	System Function
IRQ0	Timer interrupt
IRQ1	Keyboard
IRQ2	Interrupt controller cascade
IRQ3	COM 2 - used by MSIO or PCMCIA controller
IRQ4	COM 1 - used by MSIO or PCMCIA controller
IRQ5	Used by either audio or PCMCIA controller
IRQ6	Diskette Drive controller
IRQ7	Used by either EPP Parallel or Audio
IRQ8	Real-Time Clock (MSIO)
IRQ9	Used by either audio or PCMCIA controller
IRQ10	Used by either audio or PCMCIA controller
IRQ11	Used by PCMCIA
IRQ12	Mouse
IRQ13	Floating point error input
IRQ14	Hard Drive
IRQ15	Convenience base NIC interrupt

9.10 System DMA

Table 9-13

Hardware DMA	System Function
DMA 0	Fast infrared or Audio controller
DMA 1	Audio controller
DMA 2	Diskette drive controller
DMA 3	EPP Parallel Port
DMA 4	Not assigned
DMA 5	Audio Controller
DMA 6	Not assigned
DMA 7	Not assigned

9.11 System I/O Address

Table 9-14

I/O Address (Hex)	System Function (Shipping Configuration)
000 - 00F	Master DMA Controller # 1
010 - 011	Force Software SMI
012 - 01F	Unused
020 - 021	Peripheral Interrupt Controller # 1
022 - 024	Opti Chipset Configuration Registers
025 - 03F	Unused
040 - 043	Counter/Timer Registers
044 - 05F	Unused
060	Keyboard Data
061	Port B
062 - 063	Unused
064	Keyboard Command/Status
065 - 06F	Unused
070	CMOS Index Address
071	CMOS Data
072 - 073	Unused
074	Reserved
075	Unused
076	Reserved
077 - 077F	Unused
080 - 08F	DMA Page Registers
084 - 085	POST Code Output Port
090 - 091	Unused
092	Fast Reset Register
093 - 09F	Unused
0A0 - 0A1	Interrupt Controller # 2
0A2 - 0BF	Unused
0C0 - 0DF	DMA Controller # 2
0E0 - 0E1	ESS Audio Configuration
0E2 - 0E5	Configuration Registers
0E6 - 0EF	Unused
0F0 - 0F1	NCP Numerics Register
0F9	ESS Configuration Lock
0FA	Unused
0FB	ESS Configuration Unlock
0FC - 0FF	Unused
100 - 101	Unused
103 - 16F	Unused

Continued

.....

Table 9-17 *Continued*

I/O Address (Hex)	System Function (Shipping Configuration)
170 - 177	Hard Drive Secondary Registers
178 - 1EF	Unused
1F0 - 1F7	Hard Drive Primary Registers
1F8 - 1FF	Unused
200 - 21F	Unused
220 - 22F	ESS Audio Registers (1st Possible) (Default)
230 - 23F	ESS Audio Registers (2nd Possible)
240 - 24F	ESS Audio Registers (3rd Possible)
250 - 25F	ESS Audio Registers (4th Possible)
260 - 277	Unused
278 - 27A	LPT2 and High Speed Parallel Port Registers
27B - 27F	LPT2 High Speed Printer Port Registers
280 - 2F7	Unused
2F8 - 2FF	Serial Control Register COM2
300 - 36F	Unused
370 - 371	Reserved
372	Diskette Digital Output Register
373	Unused
374	Reserved
375	Diskette Main Status/Data Registers
376	Reserved
377	Diskette Input/Control Registers
378 - 37A	LPT1 and High Speed Parallel Port Registers
37B - 37F	Unused
380 - 387	Unused
388 - 38B	ESS FM Synthesizer
38C - 3AF	Unused
3B0 - 3BB	Cirrus Logic Video Controller
3BC - 3BE	LPT3 and High Speed Parallel Port Registers
3BF	LPT1 High Speed Parallel Port Registers
3C0 - 3CD	Cirrus Logic Video Controller
3D0 - 3DF	Cirrus Logic Video Controller
3F0 - 3F7	Diskette Drive Controller Primary Registers
3F8 - 3FF	COM1 Serial Controller Registers
400 - 4CF	Unused
480 - 48F	Extended DMS Registers
4D0 - CF6	Unused
CF7	Configuration/NVM Data Register
CF8 - CFB	PCI Configuration Index Register
CFC - CFF	PCI Configuration Index Register
D00 - FFF	Unused

.....

9.12 System Memory Map

Table 9-15

Size	Memory Address	System Function
640 K	00000000 - 0009FFFF	Base Memory
128 K	000A0000 - 000BFFFF	Video Memory
48 K	000C0000 - 000CBFFF	Video BIOS
160 K	000C8000 - 000E7FFF	Unused
64 K	000E8000 - 000FFFFF	System BIOS
15 M	00100000 - 00FFFFFF	Extended Memory
58 M	01000000 - 047FFFFF	Super Extended Memory
58 M	04800000 - 07FFFFFF	Unused
2 M	08000000 - 080FFFFF	Video Memory (Direct Access)
4 G	08200000 - FFFFFFFFFF	Unused
64 K	FFFF0000 - FFFFFFFF	System BIOS ("SHADOW")

Connector Pin Assignments

This appendix contains the pin assignments for all external connectors.

**Table A-1
External Keyboard**

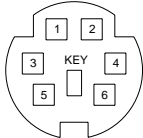
Connector	Pin	Signal
	1	Data
	2	Unused
	3	Ground
	4	+5 VDC
	5	Clock
	6	Unused

**Table A-2
PS/2-Compatible Mouse**

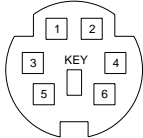
Connector	Pin	Signal
	1	Data
	2	Unused
	3	Ground
	4	+5 VDC
	5	Clock
	6	Unused

**Table A-3
MIDI/Game**

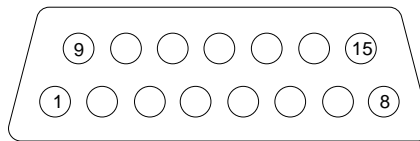

Pin	Signal	Pin	Signal
1	+5 V	9	+5 V
2	Joystick Button	10	Joystick Button
3	Joystick Direction	11	Joystick Direction
4	Ground	12	MIDI Out
5	Ground	13	Joystick Direction
6	Joystick Direction	14	Joystick Button
7	Joystick Button	15	MIDI In
8	+5 V		

.....

**Table A-4
Ethernet RJ-45**

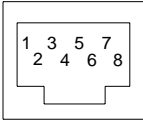
Connector	Pin	Signal
	1	(+) Transmit Data
	2	(-) Transmit Data
	3	(+) Receive Data
	4	Unused
	5	Unused
	6	(-) Receive Data
	7	Unused
	8	Unused

**Table A-5
BNC**

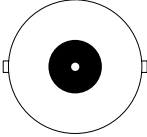
Connector	Pin	Signal
	1 (Inside)	Data
	2 (Outside)	Ground

**Table A-6
External Monitor**

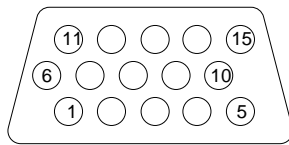

Pin	Signal	Pin	Signal
1	Red Analog	9	Blank
2	Green Analog	10	Ground
3	Blue Analog	11	Blank
4	Blank	12	Monitor ID (DD)
5	Ground	13	Horizontal Sync
6	Ground	14	Vertical Sync
7	Ground	15	Monitor ID (CC)
8	Ground		

.....

**Table A-7
Parallel**

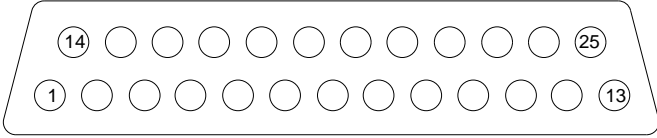

Pin	Signal	Pin	Signal
1	Strobe	14	Auto Linefeed
2	Data Bit 0	15	Error
3	Data Bit 1	16	Initialize Printer
4	Data Bit 2	17	Select In
5	Data Bit 3	18	Ground
6	Data Bit 4	19	Ground
7	Data Bit 5	20	Ground
8	Data Bit 6	21	External Diskette Positive Drive Detect
9	Data Bit 7	22	External Diskette Negative Drive Detect
10	Acknowledge	23	Ground
11	Busy	24	Ground
12	Paper End	25	External Diskette Drive Switched to +5 V
13	Select		

**Table A-8
Serial**

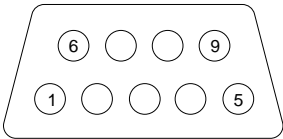

Pin	Signal	Pin	Signal
1	Carrier Detect	6	Data Set Ready
2	Receive Data	7	Ready to Send
3	Transmit Data	8	Clear to Send
4	Data Terminal Ready	9	Ring Indicator
5	Ground		

Table A-9
Expansion Connector

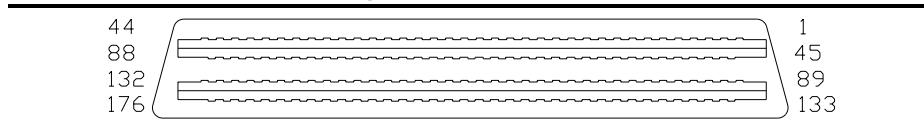

Pin	Signal	Pin	Signal
1	GND	31	GREEN
2	GND	32	CRTVSYNC
3	NC	33	RED
4	GND	34	DDCCLK
5	GND	35	PWRLED
6	NC	36	DDCDATA
7	GND	37	DOCK_PWR_EN
8	GND	38	GND
9	AD[31]	39	SPKL
10	DEVSEL	40	LINE_L
11	IRDY	41	SPK_R
12	STOP	42	LINE_R
13	TRDY	43	GND
14	GND	44	DOCK_LG
15	GND	45	GND
16	AD[12]	46	GND
17	AD[13]	47	REQ1
18	GND	48	REQ0
19	GND	49	GNT0
20	CLK1	50	RST
21	AD[0]	51	GND
22	GND	52	AD[23]
23	DOCK_S	53	AD[22]
24	CLK0	54	C/BE2
25	ACVCC	55	AD[20]
26	ACVCC	56	NC
27	ACVCC	57	AD[19]
28	ACVCC	58	FRAME
29	ACVCC	59	AD[17]
30	CRTHSYNC	60	GND

Continued

.....

Table A-9 *Continued*

Pin	Signal	Pin	Signal
61	GND	96	GND
62	AD[14]	97	CBE3
63	AD[15]	98	AD[21]
64	AD[1]	99	NC
65	AD[3]	100	NC
66	AD[2]	101	AD[18]
67	GND	102	C/BE1
68	MDATA	103	PAR
69	KBDATA	104	GND
70	MCLK	105	AD[16]
71	KBCLK	106	AD[6]
72	ACVCC	107	C/BE0
73	PMVCC5	108	AD[5]
74	PMVCC5	109	AD[7]
75	NC	110	AD[4]
76	BLUE	111	BATTLED
77	NC	112	SWC
78	PBUSY	113	TA
79	PDATA7	114	SWB
80	PBDATA3	115	SWD
81	PSLIN	116	SWA
82	GND	117	PMVCC5
83	GND	118	PMVCC5
84	SPK_IN	119	PMVCC5
85	+5v	120	PMVCC5
86	NC	121	PSELECT
87	ERDY	122	PDADA6
88	SYSVCC5A	123	PACK
89	STANDBy_SW	124	PDATA2
90	NC	125	PDATA0
91	NC	126	PFAULT
92	NC	127	GND
93	NC	128	GND
94	GNT1	129	DSRA
95	GND	130	DCDA

Continued

.....

Table A-9 *Continued*

Pin	Signal	Pin	Signal
131	RTSA	154	AD[8]
132	RIA	155	PORT_REP
133	POWER_SW	156	MSI
134	INTB	157	MSO
135	NC	158	TC
136	INTA	159	TD
137	NC	160	TB
138	GND	161	PMVCC5
139	NC	162	PMVCC5
140	AD[27]	163	PPE
141	AD[30]	164	PMVCC5
142	AD[26]	165	PDATA4
143	AD[29]	166	PDATA5
144	AD[25]	167	PDATA1
145	AD[28]	168	PINIT
146	AD[24]	169	PSTB
147	BLOCK	170	PAFD
148	GND	171	GND
149	PERR	172	GND
150	SERR	173	CTSA
151	AD[11]	174	SINA
152	AD[9]	175	DTRA
153	AD[10]	176	SOUTA

.....

Table A-10
Speaker Connector

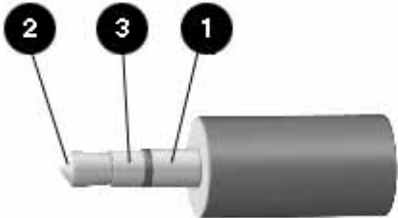

Pin	Signal
1	Shield
2	Phone Jack #1
3	Phone Jack #2

Power Cord Set Requirements

3-Conductor Power Cord Set

The wide range input feature of your computer permits it to operate from any line voltage from 100 to 240 volts AC.

The power cord set received with the computer meets the requirements for use in the country where you purchased the equipment.

Power cord sets for use in other countries must meet the requirements of the country where you use the computer.

General Requirements

The requirements listed below are applicable to all countries:

1. The length of the power cord set must be at least 5.00 feet (1.5 m) and a maximum of 6.56 feet (2.0 m).
2. All power cord sets must be approved by an acceptable accredited agency responsible for evaluation in the country where the power cord set will be used.
3. The power cord set must have a minimum current capacity of 10A and a nominal voltage rating of 125 or 250 volts AC, as required by each country's power system.
4. The appliance coupler must meet the mechanical configuration of an EN 60 320/IEC 320 Standard Sheet C5 connector, for mating with appliance inlet on the product.

.....

Country-Specific Requirements

3-Conductor Power Cord Set Requirements — By Country		
Country	Accredited Agency	Applicable Note Numbers
Australia	EANSW	1
Austria	OVE	1
Belgium	CEBC	1
Canada	CSA	2
Denmark	DEMKO	1
Finland	FIMKO	1
France	UTE	1
Germany	VDE	1
Italy	IMQ	1
Japan	JIS	3
Norway	NEMKO	1
Sweden	SEMKO	1
Switzerland	SEV	1
United Kingdom	BSI	1
United States	UL	2

Notes:

1. The flexible cord must be <HAR> Type HO3VV-F, 3-conductor, 0.75 mm² conductor size. Power cord set fittings (appliance coupler and wall plug) must bear the certification mark of the agency responsible for evaluation in the country where it will be used.
2. The flexible cord must be Type SPT-2 or equivalent, No. 18 AWG, 3-conductor. The wall plug must be a two-pole grounding type with a NEMA 5-15P (15A, 125V) or NEMA 6-15P (15A 250V) configuration.
3. The appliance coupler, flexible cord, and wall plug must bear a "T" mark and registration number in accordance with the Japanese Dentori Law. The flexible cord must be Type VCT or VCTF, 3-conductor, 0.75mm² conductor size. The wall plug must be a two-pole grounding type with a Japanese Industrial Standard C8303 (15A, 125V) configuration.

Modem Commands

This appendix contains the modem commands.

Your telephony modem must be operated under versions of Microsoft Windows later than 3.1x. The modem will not work under MS-DOS, earlier versions of Microsoft Windows, or Windows NT.

Table C-1
Modem Commands

Command	Description
AT*	Attention Code. AT is the command line prefix that tells the modem that a command or sequence of commands is being entered. It precedes all commands except the A/ (repeat) and +++ (escape) commands. Entered alone, AT causes the modem to respond with OK or 0 if it is ready to receive commands. Parameters: none
A/	Repeat Last Command. A/ causes the modem to repeat the previous command, such as redialing a telephone number. The previously executed command remains in the command buffer until AT is entered or the power is turned off. Both actions clear the buffer and make the A/ command invalid, since there is no command to repeat. It is not necessary to enter either an AT before or a <cr> after this command because they are also held in the command buffer with the previous command. Parameters: none
A	Answer Command. ATA causes the modem to answer a call without waiting for a ring. This is useful in manually answering a call or when making a direct connection with another modem in the originate mode. Parameters: none NOTE: Any command that follows A on the same command line is ignored. The A command is not permitted in some countries. In those cases, ATA returns an error.
Bn	Communications Standard Option. ATBn determines ITU or Bell standard. Parameters: n = 0 - 3, 15, 16 n = 0 ITU V.22 for 1200 bps n = 1 Bell 212A for 1200 bps (default) n = 2, 3 Deselects ITU V.23 reverse channel n = 15 ITU V.21 for 300 bps n = 16 Bell 103J for 300 bps (default)

.....

Table C-1 *Continued*

Command	Description
Dn	<p>Dial Command. ATD causes the modem to dial the number that follows D in the command line. The valid dial digits and dial modifiers are defined in the Dial Modifiers table.</p> <p>Parameters: none</p> <p>NOTE: In some countries, a telephone number is required after the ATD command. In pulse dialing, nondigit characters have no effect.</p>
En	<p>Command Echo Option. ATEn disables or enables the local echo of entered characters while the modem is in the command mode.</p> <p>Parameters: n = 0, 1</p> <p>n = 0 Disables local echo</p> <p>n = 1 Enables local echo (default)</p>
Hn	<p>Hook Control Option. ATHn controls the on-hook relay.</p> <p>Parameters: n = 0, 1</p> <p>n = 0 Modem on-hook (hang-up) (default)</p> <p>n = 1 Modem off-hook</p> <p>NOTE: The H1 command is not permitted in some countries. In those cases, ATH1 returns an error.</p>
In	<p>Request Identification Option. ATIn interrogates the modem for its product identification code, ROM checksum, or ROM checksum status.</p> <p>Parameters: n = 0, 1, 2, 4, 9</p> <p>n = 0 Returns firmware version</p> <p>n = 1 Calculates ROM checksum and displays it (for example, 12AB)</p> <p>n = 2 Performs ROM check, calculates and verifies the checksum, then displays OK or ERROR</p> <p>n = 4 Returns software version of the data pump</p> <p>n = 9 Returns country code</p>
Ln	<p>Monitor Speaker Volume. ATLn sets the speaker volume during fax and data communications to low, medium, or high.</p> <p>Parameters: n = 0 - 3</p> <p>n = 0 Low volume</p> <p>n = 1 Low volume</p> <p>n = 2 Medium volume (default)</p> <p>n = 3 High volume</p> <p>NOTE: To turn the speaker completely off, use the M0 command.</p>
Mn	<p>Speaker Control Option. ATMn controls the speaker on/off operation during fax and data communications.</p> <p>Parameters: n = 0 - 3</p> <p>n = 0 Speaker off</p> <p>n = 1 Speaker on until carrier is detected (default)</p> <p>n = 2 Speaker always on when modem is off-hook</p> <p>n = 3 Speaker on after dialing until carrier is detected</p>

.....

Table C-1 *Continued*

Command	Description
Nn	<p>Modulation Handshake. ATNn controls whether or not the local modem performs a negotiated handshake at connection time with the remote modem when the communication speeds of the two modems are different.</p> <p>Parameters: n = 0, 1</p> <p>n = 0 When originating or answering, handshake only at the communication standard specified by S37 and the ATB command.</p> <p>n = 1 When originating or answering, begin the handshake only at the communication standard specified by S37 and the ATB command. During handshake, fallback to a lower speed may occur (default).</p>
On	<p>Online Command. ATOn forces the modem to the online mode.</p> <p>Parameters: n = 0, 1, 3</p> <p>n = 0 Go online</p> <p>n = 1 Go online and initiate equalizer retrain before returning to online data mode</p> <p>n = 3 Go online and issue a rate renegotiation before returning to online data mode</p> <p>NOTE: Use this command to return to the online mode after "escaping" to the command mode.</p>
P	<p>Pulse Dial. ATP sets the dialing mode to Pulse. All calls will remain Pulse until Tone dialing is selected (T command).</p> <p>This command can also be used as a dial modifier.</p> <p>Parameters: none</p> <p>NOTE: Pulse dialing is not available in some countries. The P command is ignored in those countries.</p>
Qn	<p>Result Code Suppression. ATQn enables the modem to send result codes.</p> <p>Parameters: n = 0, 1</p> <p>n = 0 Enables result codes (default)</p> <p>n = 1 Disables return of result codes (quiet)</p>
Sr=n	<p>Write to an S Register. ATSr=n sets register "r" to the value "n." The contents of these registers can be modified with this command.</p> <p>Parameters: none</p> <p>Range: r = 0 - 27, 29, 31 - 33, 35, 37, 89 (register number)</p> <p>n = 0 - 255 (value)</p> <p>NOTE: Writing to reserved registers or read-only registers may cause unpredictable results. See the S Register command set registers.</p>

.....

Table C-1 *Continued*

Command	Description
Sn?	<p>Read an S Register. ATSn? reports the value of the register designated by "n," which may be the number of any valid S register.</p> <p>Parameters: none</p> <p>Range: n = 0 - 27, 29, 31 - 33, 35, 37, 89</p> <p>NOTE: Values are reported in decimal format. To interpret bit-mapped register values, convert the decimal value to binary.</p>
T	<p>Tone Dial. ATT sets the dialing mode to Tone. Tone dialing is the default mode.</p> <p>This command can also be used as a dial modifier.</p> <p>Parameters: none</p>
Vn	<p>Result Code Form Option. ATVn determines the type of result code returned from the modem.</p> <p>Parameters: n = 0, 1</p> <p>n = 0 Result code is sent as numbers (short form or digits)</p> <p>n = 1 Result code is sent as text (long form or verbose) (default)</p>
Xn	<p>Result Code Set/Call Progress Option. ATXn selects the result code set and dialing functions. The Vn command determines if the result code is sent as words or numbers.</p> <p>Parameters: n = 0 - 4</p> <p>n = 0 CONNECT result codes are enabled. CONNECT XXXX result codes are disabled. Busy signal and dial tone are not detected.</p> <p>n = 1 The modem blind dials: CONNECT XXXX result codes are enabled. Busy signal and dial tone are not detected.</p> <p>n = 2 The modem waits for dial tone before dialing. CONNECT XXXX result codes are enabled. Busy signal is not detected.</p> <p>n = 3 The modem blind dials: CONNECT XXXX result codes are enabled. The modem sends BUSY result code if busy signal is detected.</p> <p>n = 4 The modem waits for dial tone before dialing. CONNECT XXXX result codes are enabled. The modem sends BUSY result code if busy signal is detected (default).</p>
Z	<p>Reset Command Option. ATZ instructs the modem to go on-hook and restore the profile saved by the last &W command.</p>
<u>+++</u>	<p>Escape Code Sequence. When the character set in register S2 is sent to the modem three times in rapid succession (see S12), the modem escapes to the command state. The default value for the escape character is +. When instructed to enter +++, enter the character set in register S2 three times in rapid succession. Do not precede the escape code sequence with AT, and do not press the Enter key afterward.</p> <p>NOTE: To return to the online state, use the ATO command.</p>

.....

Table C-2
AT Commands

Command	Description
&Cn	Data Carrier Detect Options. AT&Cn controls the DCD options. Parameters: n = 0, 1 n = 0 DCD is always on; the state of the data carrier from the remote modem is ignored n = 1 DCD is on when a data carrier is detected; DCD is off when data carrier is not detected (default)
&Dn	Data Terminal Ready Option. AT&Dn controls the DTR (Data Terminal Ready) options. Parameters: n = 0 - 3 n = 0 The modem ignores DTR (default) n = 1 The modem assumes the command mode when an on-to-off transition is detected on DTR n = 2 The modem hangs up, assumes the command mode, and disables auto answer upon detecting an on-to-off transition on DTR n = 3 The modem resets upon detecting an on-to-off transition on DTR
&F	Load Factory Defaults. AT&F resets the S registers and commands to the factory default values. Parameter: n = 0 n = 0 Recall factory setting as active configuration
&Gn	Guard Tone Option. AT&Gn determines guard tone selection. Parameters: n = 0 - 2 n = 0 No guard tone (default) n = 1 550 Hz guard tone n = 2 1800-Hz guard tone
&Kn	Local Flow Control Selection. AT&Kn determines guard tone selection. Parameters: n = 0, 3, 4 n = 0 Disable flow control n = 3 Enable RTS/CTS flow control (default) n = 4 Enable XON/XOFF flow control
&Mn	Asynchronous Communications Mode. Parameter: n = 0 n = 0 Asynchronous mode (default)
&Qn	Asynchronous Communications Mode. Parameters: n = 0, 5, 6 n = 0 Asynchronous mode n = 5 Error control mode (default) n = 6 Asynchronous mode
&Sn	Data Set Ready Option. AT&Sn selects the Data Set Ready (DSR) action. Parameters: n = 0, 1 n = 0 DSR always on (default) n = 1 DSR turns on when establishing a connection and off when the connection ends

.....

Table C-2 *Continued*

Command	Description
&Tn	<p>Test Command Selection. AT&Tn selects one of eight test commands.</p> <p>Parameters: n = 0, 1, 3, 6</p> <p>n = 0 Terminates any test in progress</p> <p>n = 1 Initiates local analog loopback. If a call is in progress, an error message is returned</p> <p>n = 3 Local digital loopback test</p> <p>n = 6 Remote digital loopback test. To work properly, both modems must be on-line with error control disabled.</p>
&V	<p>View Current Configuration. AT&V displays the current configuration of S registers and commands.</p>
&W	<p>Store Current Configuration. &W stores certain command options and S-register values into the modem's nonvolatile memory. This profile is restored on an ATZ command or a power-up reset.</p>
&Zn	<p>Store Telephone Number. &Zn stores up to four dialing strings in the modem's nonvolatile memory for later dialing. The format for the command is &Zn="stored number", where n is the location 0 - 3 to which the number may be written. The dial string may contain up to 40 characters. ATDS=n dials using the string stored in location n.</p>
\Nn	<p>Error Control Mode. AT\Nn selects the protocol used by the modem when sending or receiving data.</p> <p>Parameters: n = 0 - 4</p> <p>n = 0 Buffer mode (no error control)</p> <p>n = 1 Direct mode (no error control)</p> <p>n = 2 MNP (Microcom Networking Protocol) or disconnect</p> <p>n = 3 V.42, MNP, or buffer mode (default)</p> <p>n = 4 V.42 or disconnect</p>
\Qn	<p>Local Flow Control Selection.</p> <p>Parameters: n = 0, 1, 3</p> <p>n = 0 Disable flow control</p> <p>n = 1 XON/XOFF software flow control</p> <p>n = 3 RTS/CTS to DTE (Data Terminal Equipment)</p>
\Vn	<p>Protocol Result Code. AT\Vn selects display of protocol connection.</p> <p>Parameters: n = 0, 1</p> <p>n = 0 Disable protocol result code appended to DCE (Data Communications Equipment) speed</p> <p>n = 1 Enable protocol result code appended to DCE speed (default)</p>

.....

Table C-2 *Continued*

Command	Description
-Cn	Data Calling Tone. Data calling tone is a tone of 130 Hz frequency with a cadence of 0.5 seconds on and 2 seconds off. The tone is specified in ITU V.25 to allow remote data/fax/voice discrimination. Parameters: n = 0, 1 n = 0 Disable data calling tone (default) n = 1 Enable data calling tone NOTE: In some countries, AT-Cn will return OK but will not affect the calling tone. Default value varies by country
%B	View Numbers in Blacklist Displays blacklisted numbers if blacklisting is in effect.
%Cn	Data Compression Control. ATnCn determines the operation of V.42bis and MNP class 5 data compression. Changes made with this command during online command mode do not take effect until after a disconnect occurs. Parameters: n = 0, 1 n = 0 V.42bis/MNP5 disabled; no data compression n = 1 V.42bis/MNP5 enabled; data compression enabled (default)
To enable speakerphone mode, use the following AT Commands:	
AT+FCLASS=8	Enter voice mode.
AT+VGT=nnn	Set speaker volume; nnn=0-255
AT+VGR=128	Set microphone gain; 0-255
AT+VLS=7	Set up speaker and microphone; go off hook
ATDT<phone number>	Dial the phone number.
To disconnect speakerphone mode, use the following AT command:	
+++	Return to command mode. The response is 'OK'.
AT+VLS=0	Go on hook.

.....

Table C-3
Fax Commands

Command	Description										
+F<command>=?	<p>Report Operating Capabilities. AT+F<command>=? determines the operating capabilities of the modem.</p> <p>Responses:</p> <table style="margin-left: 40px; border: none;"> <tr> <td style="padding-right: 20px;">+FCLASS = ?</td> <td>0, 1, 8, 80</td> </tr> <tr> <td style="padding-right: 20px;">+FTM =</td> <td>?3, 24, 48, 72, 96, 73, 74, 97, 98, 121, 122, 145, 146</td> </tr> <tr> <td style="padding-right: 20px;">+FRM = ?</td> <td>3, 24, 48, 72, 96, 73, 74, 97, 98, 121, 122, 145, 146</td> </tr> <tr> <td style="padding-right: 20px;">+FTH = ?</td> <td>3, 24, 48, 72, 96, 73, 74, 97, 98, 121, 122, 145, 146</td> </tr> <tr> <td style="padding-right: 20px;">+FRH = ?</td> <td>3, 24, 48, 72, 96, 73, 74, 97, 98, 121, 122, 145, 146</td> </tr> </table>	+FCLASS = ?	0, 1, 8, 80	+FTM =	?3, 24, 48, 72, 96, 73, 74, 97, 98, 121, 122, 145, 146	+FRM = ?	3, 24, 48, 72, 96, 73, 74, 97, 98, 121, 122, 145, 146	+FTH = ?	3, 24, 48, 72, 96, 73, 74, 97, 98, 121, 122, 145, 146	+FRH = ?	3, 24, 48, 72, 96, 73, 74, 97, 98, 121, 122, 145, 146
+FCLASS = ?	0, 1, 8, 80										
+FTM =	?3, 24, 48, 72, 96, 73, 74, 97, 98, 121, 122, 145, 146										
+FRM = ?	3, 24, 48, 72, 96, 73, 74, 97, 98, 121, 122, 145, 146										
+FTH = ?	3, 24, 48, 72, 96, 73, 74, 97, 98, 121, 122, 145, 146										
+FRH = ?	3, 24, 48, 72, 96, 73, 74, 97, 98, 121, 122, 145, 146										
+F<command>=n?	<p>Report Supported Parameters. AT+F<command>=n? interrogates the modem as to whether or not that function is supported. The modem responds with OK if the parameter issued for the specific command is supported or responds with ERROR if it is not supported.</p>										
+FCLASS?	<p>Report Active Configuration. AT+FCLASS? interrogates the modem to determine the active configuration.</p> <p>Responses:</p> <ul style="list-style-type: none"> 0 = Data mode 1 = Fax mode 8 = Voice mode 80 = VoiceView mode 										
+FCLASS=n	<p>Select Service Class. AT+FCLASS=n selects the class (kind) of service desired.</p> <p>Parameters: n = 0, 1, 8, 80</p> <ul style="list-style-type: none"> n = 0 Data mode (default) n = 1 Fax Class 1 n = 8 Voice mode n = 80 VoiceView mode 										
+FTS=n	<p>Stop Transmission and Wait. AT+FTS causes the modem to terminate a transmission. The transmission is terminated and the modem waits for n 10-millisecond intervals before responding with the OK result code.</p> <p>Parameters: n = 0 - 255 (10 ms intervals) (default = 0)</p> <p>An ERROR response code results if this command is issued while the modem is on-hook.</p>										
+FRS=n	<p>Receive Silence. AT+FRS causes the modem to report back to the DTE with an OK result code after n 10-millisecond intervals of silence have been detected on the line.</p> <p>Parameters: n = 0 - 255 (10 ms intervals) (default = 0)</p> <p>This command is aborted if any character is received. The modem discards the aborting character and issues an OK result code. An ERROR response code results if this command is issued while the modem is on-hook.</p>										

.....

Table C-3 *Continued*

Command	Description
+FTM=n	<p>Transmit Data. AT+FTM causes the modem to transmit data using the modulation defined below.</p> <p>Parameters: n = 3, 24, 48, 72, 73, 74, 96, 97, 98, 121, 122, 145, 146</p> <p>n = 3 V.21 Channel 2 300 bps</p> <p>n = 24 V.27ter 2400 bps</p> <p>n = 48 V.27ter 4800 bps (default)</p> <p>n = 72 V.29 7200 bps</p> <p>n = 73 V.17 7200 bps</p> <p>n = 74 V.17 7200 bps (short train)</p> <p>n = 96 V.29 9600 bps</p> <p>n = 97 V.17 9600 bps</p> <p>n = 98 V.17 9600 bps (short train)</p> <p>n = 121 V.17 12000 bps</p> <p>n = 122 V.17 12000 bps (short train)</p> <p>n = 145 V.17 14400 bps</p> <p>n = 146 V.17 14400 bps (short train)</p> <p>An ERROR response code results if this command is issued while the modem is on-hook.</p>
+FRM=n	<p>Receive Data. AT+FRM causes the modem to enter the receiver mode using the modulation defined below.</p> <p>Parameters: n = 3, 24, 48, 72, 73, 74, 96, 97, 98, 121, 122, 145, 146</p> <p>n = 3 V.21 Channel 2 300 bps</p> <p>n = 24 V.27ter 2400 bps</p> <p>n = 48 V.27ter 4800 bps (default)</p> <p>n = 72 V.29 7200 bps</p> <p>n = 73 V.17 7200 bps</p> <p>n = 74 V.17 7200 bps (short train)</p> <p>n = 96 V.29 9600 bps</p> <p>n = 97 V.17 9600 bps</p> <p>n = 98 V.17 9600 bps (short train)</p> <p>n = 121 V.17 12000 bps</p> <p>n = 122 V.17 12000 bps (short train)</p> <p>n = 145 V.17 14400 bps</p> <p>n = 146 V.17 14400 bps (short train)</p> <p>An ERROR response code results if this command is issued while the modem is on-hook or if a non-supported command is issued.</p>

.....

Table C-3 *Continued*

Command	Description
+FTH=n	<p>Transmit Data with HDLC Framing. AT+FTH causes the modem to transmit data framed in HDLC protocol using the modulation defined below:</p> <p>Parameters: n = 3, 24, 48, 72, 73, 74, 96, 97, 98, 121, 122, 145, 146</p> <p>n = 3 V.21 Channel 2 300 bps</p> <p>n = 24 V.27ter 2400 bps</p> <p>n = 48 V.27ter 4800 bps (default)</p> <p>n = 72 V.29 7200 bps</p> <p>n = 73 V.17 7200 bps</p> <p>n = 74 V.17 7200 bps (short train)</p> <p>n = 96 V.29 9600 bps</p> <p>n = 97 V.17 9600 bps</p> <p>n = 98 V.17 9600 bps (short train)</p> <p>n = 121 V.17 12000 bps</p> <p>n = 122 V.17 12000 bps (short train)</p> <p>n = 145 V.17 14400 bps</p> <p>n = 146 V.17 14400 bps (short train)</p> <p>An ERROR response code results if this command is issued while the modem is on-hook.</p>
+FRH=n	<p>Receive Data with HDLC Framing. AT+FRH causes the modem to receive HDLC framed data using the modulation defined below:</p> <p>Parameters: n = 3, 24, 48, 72, 73, 74, 96, 97, 98, 121, 122, 145, 146</p> <p>n = 3 V.21 Channel 2 300 bps</p> <p>n = 24 V.27ter 2400 bps</p> <p>n = 48 V.27ter 4800 bps (default)</p> <p>n = 72 V.29 7200 bps</p> <p>n = 73 V.17 7200 bps</p> <p>n = 74 V.17 7200 bps (short train)</p> <p>n = 96 V.29 9600 bps</p> <p>n = 97 V.17 9600 bps</p> <p>n = 98 V.17 9600 bps (short train)</p> <p>n = 121 V.17 12000 bps</p> <p>n = 122 V.17 12000 bps (short train)</p> <p>n = 145 V.17 14400 bps</p> <p>n = 146 V.17 14400 bps (short train)</p> <p>An ERROR response code results if this command is issued while the modem is on-hook.</p>

.....

**Table C-4
Dial Modifiers**

Modifier	Description
L	Redial Last Number. L instructs the modem to redial the last number dialed since power was applied to the system. This should be the first command after ATD; otherwise, the modem ignores the command.
P	Pulse Dialing. P instructs the modem to use pulse dialing until tone dialing (T) is selected.
S=n	Dial Stored Number. S=n instructs the modem to dial a telephone number previously stored using the &Zn=number command. The range of n is 0 - 3.
T	Tone Dialing. T instructs the modem to use tone dialing until pulse dialing (P) is selected. Tone duration and spacing are set by the S11 register.
W	Wait for Dial Tone. W causes the modem to wait up to a specified time for the dial tone to occur. The telephone number is dialed immediately upon dial tone detection. This may be helpful when dialing through a PBX or for some long-distance services. The maximum wait period is set in register S7.
;	Return to Command Mode. The semicolon (;) forces the modem to remain in the command state after dialing a number without disconnecting. The semicolon must be placed at the end of the dial command.
@ (at character)	Wait for Quiet Answer Command. The at character, @, causes the modem to look for rings followed by seconds of silence before processing the next symbol in the dial string. The S7 register determines the maximum wait time. If a quiet answer is detected, the dial modifiers following the command are executed. If a busy signal is detected, the modem returns a BUSY result code and undergoes the hang-up process, aborting further execution of commands.
! (exclamation)	Flash Hook Command. The exclamation point, (!), causes the modem to go on-hook for 0.5 seconds and then return to off-hook. Used by some PBX systems to access special features such as call forwarding and call transfer.
, (comma)	Pause During Dialing. The comma (,) causes the modem to pause for a specified time during dialing. The duration is set by register S8.
^ (carat)	Disable Data Calling Tone Transmission. This command takes effect for the current call only. NOTE: This command is not available in some countries.
> (greater than)	Ground Start Dialing. NOTE: This command is not available in some countries.
0 through 9	Dial Digits. Valid digits for pulse or tone dialing.
A, B, C, D, #, *	Dial Characters. Valid characters for tone dialing only. A, B, C, and D are four keys added to the right of the 369# keys for Dual-Tone Multifrequency systems.

NOTES Telephone numbers (dial strings) may be entered with or without spaces or other punctuation.
T and P modifiers are allowed anywhere in the dial string; therefore, signaling methods may be changed in some countries after several digits are sent, if allowed in your country.

.....

•

Notice

The information in this guide is subject to change without notice.

COMPAQ COMPUTER CORPORATION SHALL NOT BE LIABLE FOR TECHNICAL OR EDITORIAL ERRORS OR OMISSIONS CONTAINED HEREIN; NOR FOR INCIDENTAL OR CONSEQUENTIAL DAMAGES RESULTING FROM THE FURNISHING, PERFORMANCE, OR USE OF THIS MATERIAL.

This guide contains information protected by copyright. No part of this guide may be photocopied or reproduced in any form without prior written consent from Compaq Computer Corporation.

© 1998 Compaq Computer Corporation.
All rights reserved. Printed in the U.S.A.

Compaq, LTE, Contura, ProLinea, QuickLock, QuickBlank are registered in the U. S. Patent and Trademark Office. Armada is a trademark of Compaq Computer Corporation.

Contura is registered in the Philippines Patent Office.

Microsoft, MS-DOS, and Windows are registered trademarks of Microsoft Corporation. Windows 95 is a trademark of Microsoft Corporation.

The software described in this guide is furnished under a license agreement or nondisclosure agreement. The software may be used or copied only in accordance with the terms of the agreement. Product names mentioned herein may be trademarks and/or registered trademarks of their respective companies.

Maintenance and Service Guide Addendum

Compaq Armada 1500 Family of Personal Computers

First Edition (January 1998)
Spare Part Number 255011-001
Document Part Number 255318-001

Compaq Computer Corporation

Computer Product Description

1.1 Models and Features

The following information describes new models and features of the Compaq Armada 1500 Family of Personal Computers. Selected models include Pentium processors with MMX technology, faster internal modem, larger hard drive, faster internal CD-ROM drive, and mechanical enhancements to the base enclosure. A list of standard features and supported options are provided in Chapter 1 of the *Maintenance and Service Guide, Compaq Armada 1500 Family of Personal Computers*. The following computer models are available:

Compaq Armada 1500 Family Models								
Model	Pentium Processor	Display	Hard Drive	Memory Std / Max	Level 2 Cache	CD-ROM	Modem (Kbps)	Serial Configuration
1530D	133-MHz	12.1 STN	1.4-GB	16/80 MB	256-Kbyte	10X	—	BRX1
1530DM	133-MHz	12.1 STN	1.4-GB	16/80 MB	256-Kbyte	10X	33.6	BRX2
1535DM	133-MHz	12.1 STN	1.4-GB	16/80 MB	256-Kbyte	12X	33.6	BRX3
1540D	150-MHz	12.1 TFT	2.1-GB	16/80 MB	256-Kbyte	20X	—	BRX5
1540DM	150-MHz	12.1 TFT	2.1-GB	16/80 MB	256-Kbyte	20X	33.6	BRX6
1545DM	150-MHz	12.1 TFT	2.1-GB	16/80 MB	256-Kbyte	20X	56	BT61
1560	166-MHz	12.1 STN	2.1-GB	16/80 MB	256-Kbyte	—	—	BT51
1560D	166-MHz	12.1 STN	2.1-GB	16/80 MB	256-Kbyte	20X	—	BT52
1560DM	166-MHz	12.1 STN	2.1-GB	16/80 MB	256-Kbyte	20X	56	BT53
1580DT	150-MHz	12.1 TFT	2.1-GB	16/80 MB	256-Kbyte	10X	—	BM58
1580DMT	150-MHz	12.1 TFT	2.1-GB	16/80 MB	256-Kbyte	10X	33.6	BM59
1585DMT	150-MHz	12.1 TFT	2.1-GB	16/80 MB	256-Kbyte	12X	33.6	BRX4
1590DT	166-MHz	12.1 TFT	2.1-GB	16/80 MB	256-Kbyte	20X	—	BRX7
1590DMT	166-MHz	12.1 TFT	2.1-GB	16/80 MB	256-Kbyte	20X	33.6	BRX8
1592DT	233-MHz MMX	12.1 TFT	3.2-GB	32/96 MB	512-Kbyte	20X	—	BT54
1592DMT	233-MHz MMX	12.1 TFT	3.2-GB	32/96 MB	512-Kbyte	20X	56	BT55

1.2 Features

The following features are provided on selected models:

- EDO Dynamic Random Access Memory (DRAM) system memory: 16-MB expandable to 80-MB, or 32-MB expandable to 96-MB
- 1.44-GB, 2.1-GB or 3.2-GB hard drive
- 11.3-inch Super Twisted Neumatic (STN) or 12.1-inch Thin Film Transistors (TFT) SVGA display
- 33.6Kbps integrated modem or 56Kbps internal controllerless modem. (Both are standard on selected models and available as an option on other models.)
- Internal CD-ROM Drive standard on selected models and available as an option on other models
- Universal Serial Bus (USB) connector standard on selected models
- 2-MB video memory
- 256-Kbyte L2 Cache memory, or 512-Kbyte L2 Cache memory
- Two standard device slots that will accommodate two types I and II and one type III PC Cards, PCMCIA and Bus cards; Compaq Telephony modem in the top slot and Zoomed-Video in the bottom slot

The following features are provided on all models:

- Supports Lithium Ion (Li-ion) and Nickel Metal Hydride (NiMH) modular battery packs
- SoundBlaster-compatible audio controller with internal stereo speakers and internal microphone
- Full-size 101 key compatible keyboard including 12 function keys, 8 cursor control keys, inverted-T cursor control keys and embedded numeric keypad
- Four user-programmable keys
- Touchpad pointing device
- Operates from an internal battery pack, plus an optional battery pack in the Dualbay, or integrated AC power that is compatible with domestic and international power sources
- Power management and security features

- Infrared interface for wireless communications with other IrDA-compliant devices at data rates up to 4 MB/sec
- 176 pin expansion connector provides the interface to the Convenience Base options
- Rear-panel ports provide connections for parallel and serial, external monitor, keyboard/mouse and IrDA compliant infrared devices

1.3 Software Fulfillment

Replacement software may be ordered directly from Compaq Computer Corporation. Both the model and the serial number of the computer are needed to identify the specific software available.

1.4 External Computer Components

The following information provides new mechanical changes to the models, which are different from earlier models



Universal Serial Bus

A **Universal Serial Bus (USB) connector** has been added to select models on the left side of the computer. The connector provides an interface for USB peripheral devices.

On models without the USB connector, a plastic insert covers the connector space. The plastic USB cover is included in spare part 254981-001, the miscellaneous spare parts kit. The kit also ships with such items as replacement clutch covers, rubber feet, battery spacer door, etc. (See Chapter 4 in the *Maintenance and Service Guide* for miscellaneous spare parts.)

Battery Spacer Door

IMPORTANT: The Battery Spacer Door, which is a component of the Dualbay compartment, has been modified.

The new battery spacer door pushes  pushes inward with a single motion, as compared to the previous version  which pulled out and pushed inward (Figure 1-1).

NOTE: The Battery Spacer Door is included in the miscellaneous spare parts kit (spare part 254981-001).



Figure 1-1. New Battery Spacer Door

Illustrated Parts for the Computer

4.0 Illustrated Parts for the Computer

For an illustrated parts breakdown, refer to the *Illustrated Parts Map*. The following information provides new spare parts descriptions and part numbers.

The following tables are updated to include the new spare parts. For illustrations of spare parts, refer to the *Maintenance and Service Guide, Compaq Armada 1500 Personal Computers* or *Illustrated Parts Map*.

**Table 4-1
System Unit**

Description	Model(s)	Spare Part Number
Keyboard Assembly		
US/Canada	All models	254968-001
Belgian	All models	254968-181
Brazilian	All models	254968-035
Danish	All models	254968-081
French	All models	254968-051
French Canadian	All models	254968-121
German	All models	254968-041
Italian	All models	254968-061
Japanese	All models	254968-191
Korean	All models	254968-033
Latin American	All models	254968-161
Norwegian	All models	254968-101
Portuguese	All models	254968-131
Spanish	All models	254968-071
Swedish/Finnish	All models	254968-091
Swiss	All models	254968-111
Taiwanese	All models	254968-034
UK	All models	254968-031
Top Cover Assembly (keyboard cover)	All models	254978-001
Speakers	All models	254979-001
Base enclosure assembly	1510, 1510DM, 1520, 1520D, 1520DM, 1530D, 1530DM, 1535DM, 1550T, 1550DMT, 1575DMT, 1580DT, 1580DMT, 1590DT, 1590DMT	254969-001
Base enclosure assembly	1540D, 1540DM, 1560DT, 1560DMT, 1590DT, 1590DMT	212535-001
Display Assembly		
11.3 inch STN	1510, 1510DM, 1520, 1520D, 1520DM	254966-001
12.1 inch TFT	1550T, 1550DMT, 1580DT, 1580DMT, 1585DMT, 1590DT, 1590DMT	254967-001
12.1 inch TFT	1592DT, 1592DMT	255308-001
12.1 inch STN	1530, 1530D, 1530DM, 1535DM, 1540D, 1540DM, 1560, 1560D, 1560DM	255131-001

**Table 4-2
Mass Storage Devices**

Description	Model(s)	Spare Part Number
CD-ROM		
10X CD-ROM Drive	1510DM, 1520D, 1520DM, 1550DMT, 1530D, 1530DM, 1580DT, 1580DMT	254974-001
20X Max CD-ROM Drive	1540D, 1540DM, 1560D, 1560DM, 1560DT, 1560DMT, 1590DT, 1590DMT, 1592DT, 1592DMT	255215-001
Hard Drive		
1.08GB, 3 inch /2.5 inch	1510, 1510DM, 1520, 1520D, 1520DM	254963-001
1.44GB, 3 inch/2.5 inch	1530, 1530D, 1530DM, 1535DM, 1550T, 1550DMT	254964-001
2.1-GB	1540D, 1560, 1580DT, 1580DMT, 1585DMT, 1590DT	255130-001
3.2-GB	1560D, 1560DM, 1592DT, 1592DMT	255248-001
Diskette Drive		
1.44MB Diskette Drive	All models	254962-001
Battery Packs		
NiMH	All models	254959-001
Li-Ion	All models	254960-001

Table 4-3
Cables and Power Cords

Description	Model(s)	Spare Part Number
CD-ROM Cable	All models	254975-001
Modem Cable	All models	165224-001
AC Adapter, internal	All models	254961-001
AC Power Cord	Refer to the <i>Maintenance & Service Guide</i>	Refer to the <i>Maintenance & Service Guide</i>
RTC Battery (with cable)	All models	254971-001
Microphone	All models	254981-001
Fan	1510, 1510DM, 1520, 1520D, 1520DM, 1530D, 1530DM, 1535DM, 1550T, 1550DMT, 1575DMT, 1580DT, 1580DMT, 1585DMT	254977-001
Fan	1540D, 1540DM, 1560, 1560D, 1560DM, 1590DT, 1590DMT, 1592DT, 1592DMT	255194-001

Table 4-4
Standard and Optional Boards

Description	Model(s)	Spare Part Number
LED Board		
11.3 inch display LED board	1510, 1510DM, 1520, 1520D, 1520DM	254958-001
12.1 inch TFT display LED board	1550T, 1550DMT, 1580DT, 1580DMT, 1585DMT	255049-001
12.1 inch STN display LED board	1530, 1530D, 1530DM, 1535DM, 1540D, 1540DM, 1560, 1560D, 1560DM	255189-001
12.1 inch TFT display LED board	1590DT, 1590DMT, 1592DT, 1592DMT	255190-001
I/O Fixture Connector	All models	254956-001
DC/DC Converter Board	All models (except MMX models)	254976-001
DC/DC Converter Board, 2.5 / 2.45 / 2.9v	All MMX models except as noted below	255161-001
DC/DC Converter Board, 1.8v	Armada 1592	255262-001
Audio Board	All models	254957-001
System CPU Board		
120-MHz processor	1510, 1510DM	254949-001
133-MHz processor	1520, 1520D, 1520DM, 1550T, 1550DMT	255010-001
133-MHz processor with MMX	1530, 1530D, 1530DM, 1535DM	255129-001
150-MHz processor	1580DT, 1580DMT, 1585DMT	255071-001
150-MHz processor with MMX	1540D, 1540DM	255187-001
166-MHz processor with MMX	1560, 1560D, 1560DM	255310-001
166-MHz processor with MMX	1590DT, 1590DMT	255188-001
233-MHz MMX processor	1592DT, 1592DMT	255246-001

**Table 4-5
Options**

Description	Models	Spare Part Number
Power Cord		
US/Canada/Latin America/Brazil	All models	246959-001
Australia/New Zealand	All models	246959-011
Denmark	All models	246959-081
Europe	All models	246959-021
Italy	All models	246959-061
Japan	All models	246959-291
Korea	All models	246959-AD1
Switzerland	All models	246959-AG1
UK/Singapore	All models	246959-031
Automobile Adapter	All models	218079-001
Battery Packs		
NiMH	All models	254959-001
Li-Ion	All models	254960-001
Battery Charger	All models	950970-001

**Table 4-6
Miscellaneous Parts**

Description	Model(s)	Spare Part Number
Miscellaneous Plastics Kit, includes: Left clutch cover Microphone/display cable cover Right clutch cover Battery spacer door CD-ROM access door Modem access door Rubber feet	All models All models with integrated CD-ROM drives	254981-001
Display Logos	All models	255013-001
Hinge and Latch Kit, includes: Display clutch retaining plate (2 each) Display clutch (2 each) Display latch (2 each) Display latch spring (2 each) Rubber screw covers (4 each)	All models	254982-001
Miscellaneous Screw Kit, includes T-8, long (50 each) T-8, short (10 each) T-8, with Ny-Loc (4 each) 7mm (10 each) 5 mm (10 each)	All models	254980-001
Miscellaneous Plastics Kit	All models	254981-001
Maintenance and Service Guide	All models	255011-001
Illustrated Parts Map	All models	255012-001
Armada 1500 Software CD	All models	255097-001
Quick Restore Software CD for model 1535DM	All models	255180-001
Quick Restore Software CD for model 1585DMT	All models	255181-001

**Table 4-7
Accessories**

Description	Models	Spare Part Number
Power Cord		
US/Canada/Latin America/Brazil	All models	246959-001
Australia/New Zealand	All models	246959-011
Denmark	All models	246959-081
Europe	All models	246959-021
Italy	All models	246959-061
Japan	All models	246959-291
Korea	All models	246959-AD1
Switzerland	All models	246959-AG1
UK/Singapore	All models	246959-031
Automobile Adapter	All models	218079-001
Battery Packs		
NiMH		254959-001
Li-Ion		254960-001
Battery Charger		950970-001
Convenience Bases		
Convenience Base Pass-Through model		254988-001
Convenience Base Ethernet model with 10BaseT		254987-001
Convenience Base BNC model with 10BaseT		254989-001
Monitor Stand		254990-001
100BaseT Ethernet Upgrade		225436-001
Modem		
33.6 Data/Fax Modem with install diskette	1510DM, 1520DM, 1530DM, 1535DM, 1540DM, 1550DMT, 1580DMT, 1585DMT, 1590DMT	North America 255014-001 Japan 255014-191 Asia 255014-371
56K Voice / Fax / Data Modem (controllerless, integrated)	1560DM, 1592DMT	255245-001
Modem Cable (RJ11)	All models	165224-001
10' AC Power Cord Extension		
US	All models	255135-001
Australia	All models	255135-011
Denmark	All models	255135-081
Europe	All models	255135-021
Italy	All models	255135-061
Japan	All models	255135-291
Korea	All models	255135-AD1
UK	All models	255135-031
Singapore	All models	255135-111

Option Spares

**Table 4-8
Accessories**

Description	Models	Spare Part Number
Memory Expansion Board		
8MB	All models	272108-001
16MB	All models	272110-001
32MB	All models	220583-001
64MB	All models	273158-001
CD-ROM Drive		
10X CD-ROM Drive	All models	254974-001
20X Max CD-ROM Drive	All models	255215-001
56K Voice/Fax/Data Modem (Controllerless, Integrated)	All models	255245-001
33.6 Data/Fax Modem (Integrated)	All models	255014-001

9.0 Specifications

This chapter provides specifications on the following new components:

- 2.1-GB Hard Drive
- 3.2-GB Hard Drive
- 20X Max CD-ROM
- 12.1-inch TFT, SVGA display

**Table 9-1
Hard Drives**

Standard Model Configurations	2.1-GB	3.2-GB
Formatted Capacity Per Drive (MB)		
Physical	2.16	3.24
Logical	2.1	3.2
Drive Type		
	65	65
Drive Height		
With drive frame (mm)	12.7mm	12.7mm
Drive Size		
Inches	3.94 x 2.75	4.01 x 2.75
Millimeters	100.2 x 69.85	102 x 69.85
Transfer Rate		
Media (Mb/s)	38.1 to 54.8	51.7 to 83.4
Interface (Mb/s)	16.6	33.3
Sector Interleave		
	1:1	1:1
Typical Seek Time (including setting)		
Single Track (ms)	4	4
Average (ms)	13	13
Full Stroke (ms)	23	23
Disk Rotational Speed		
	4,200	4,000
Physical Configuration		
Cylinders	4928	6975
Data Heads	6	5
Sectors per Track	110-180	144-240
Bytes per Sector	512	512
Logical Configuration		
Cylinders	4200	6304
Data Heads	16	16
Sectors per Track	63	63
Bytes per Sector	512	512
Buffer Size		
	128	128

Table 9-2
20X Max CD-ROM Drive

Applicable Disc	CD-ROM mode 1, mode 2 CD-Digital Audio CD-XA mode 2 (Form 1, Form 2) CD-I mode 2 (Form 1, Form 2) CD-I Ready CD-Bridge CD-WO (fixed / variable packets) Photo CD (single / multi-session)
Center Hole Diameter	15mm
Disc Diameter	12cm, 8cm
Disc Thickness	1.2mm
Track Pitch	1.6 μ m
Laser	
Beam Divergence	53.5 \pm 1.5 degrees
Output Power	0.13 \pm 0.1 mw
Type	Semiconductor Laser GaA1As
Wave Length	780 nm \pm 25 nm
Access Time	
Random	< 150 ms
Full Stroke	< 600 ms
Audio Output Level	
Line Out	0.7 Vrms
Headphone	None
Cache Buffer	256 KB
Data Transfer Rate	
Sustained, quad	300 MB/sec
Sustained, single	150 KB/sec
Burst	8.3 MB/sec
Startup Time	< 10 seconds typical
Capacity	
Mode 1, 12 cm	550 MB
Mode 2, 12 cm	640 MB
8 cm	180 MB

Table 9-3
12.1-inch TFT, SVGA Display

	U.S.	Metric
Dimensions		
Height	7.24 in.	184 mm
Width	9.7 in.	245 mm
Number of Colors	16 million	16 million
Contrast Ration	Over 100:1	Over 100:1
Pixel Resolution		
Pitch	0.30 x 0.30 mm	0.30 x 0.30 mm
Format	800 x 600	800 x 600
Configuration	RGB Stripe	RGB Stripe
Backlight	130 cd/m ²	130 cd/m ²

Appendix C

Modem Commands

This section includes modem commands for the 56Kbps internal modem. The telephony modem is designed to operate with the preinstalled software in the computer. The modem is compatible with Microsoft Windows 95 (and later) or Windows NT 4.0.

Table C-1
Modem Commands

Command	Description
A	Answer Command. A instructs the modem to go off-hook and answer an incoming call.
Bn	Communication Standard Setting. Bn determines CCITT vs. Bell standard. 0: Selects CCITT V.22 mode when the modem is at 1200bits/s 1: Selects Bell 212A when the modem is at 1200bits/s (default). 2: Unselects V23 reverse channel (same as B3). 3: Unselects V23 reverse channel (same as B2). 15: Selects V.21 when the modem is at 300 bits/s 16: Selects Bell 103J when the modem is at 300 bits/s (default). Result Codes: OK n=0, 1, 15, 16 ERROR Otherwise
Cn	Carrier Control. The modem will accept the C1 command without error in order to assure backward compatibility with communications software that issues the C1 command. However, this modem does not support the C0 command. The C0 command may instruct some earlier modems (such as the Smartmodem 1200) to not send carrier (ie., it puts them in a receive-only mode). 0: Transmit carrier always off. 1: Normal transmit carrier switching. Result Codes: OK n=1 ERROR Otherwise

Continued

Table C-1, Modem Commands, Continued

Command	Description
Dn	<p>Dial Command. Dn instructs the modem to begin the dialing sequence. The dial string (n, including modifiers and the telephone number) is entered after the ATD command. A dial string can be up to 40 characters long. Any digit or symbol (0–9, *, #, A, B, C, D) may be dialed as touch tone digits. Characters such as spaces, hyphens, and parentheses do not count—they are ignored by the modem and may be included in the dial string to enhance readability.</p> <p>The following may be used as dial string modifiers:</p> <ul style="list-style-type: none"> L Redials last number. Should be the first character following TD, ignored otherwise. P Pulse dialing T Touch-tone dialing (default). V The modem switches to speakerphone mode and dials the number. An ATH command may be used to disconnect the voice call. , Pause during dialing. Pause for time specified in Register S8 before processing the next character in the dial string. W Wait for dial tone. Modem waits for a second dial tone before processing the dial string. @ Wait for quiet answer. Wait for five seconds of silence after dialing the number. If silence is not detected, the modem sends a NO ANSWER result code back to the user. ! Hook flash. Causes the modem to go on-hook for 0.5 seconds and then return to off-hook. ; Return to command mode. Causes the modem to return to command mode after dialing the number, without disconnecting the call. ^ Disable data calling tone transmission. A, B, C, D Letters (DTMF tone dialing mode only) S=n Dial a telephone number previously stored using the &Zn=x command (see the &Zn=x command for further information). The range of n is 0–3. \$ Bong tone detection. <p>The dial modifiers listed above (except S) shall be saved when dial strings are stored. The T and P modifiers are allowed anywhere in the dial string so signaling methods may be changed after some digits are already sent.</p>
En	<p>Echo Command. En controls whether or not the characters entered from your computer keyboard are echoed back to your monitor while the modem is in command mode.</p> <ul style="list-style-type: none"> 0: Disables echo to the computer. 1: Enables echo to the computer (default). <p>Result Codes:</p> <ul style="list-style-type: none"> OK n=0, 1 ERROR Otherwise
Fn	<p>Online Echo Control. Fn determines if the modem will echo data from the DTE. This modem does not support the F0 version of the command. However, the modem will accept F1, which may be issued by older communication software, to assure backward compatibility.</p> <ul style="list-style-type: none"> 0: Online data character echo enabled (NOT SUPPORTED, ERROR). 1: Online character echo disabled. <p>Result Codes:</p> <ul style="list-style-type: none"> OK n=1 ERROR Otherwise

Continued

Table C-1, Modem Commands, *Continued*

Command	Description																
Hn	<p>Hook Control. Note that in some countries H1 will be limited by a timer (i.e., the maximum time off-hook without a carrier negotiation). In those cases, S7 or a hardcoded constant will be used for the upper limit of this timer.</p> <p>0: Modem goes on-hook (default). 1: Modem goes off-hook.</p> <p>Result Codes: OK n=0, 1 ERROR Otherwise</p>																
In	<p>Request ID Information. In displays specific product information about the modem.</p> <p>0: Returns default speed and controller firmware version, same as I3. 1: Calculates ROM checksum and displays it on the DTE (ie. F15D). 2: Performs a ROM check and calculates and verifies the checksum displaying OK or ERROR. 3: Returns the default speed and the controller firmware version, same as I0. 4: Returns firmware version for data pump (ie. 57). 5: Returns the board ID: software version, hardware version, and country ID.</p> <table border="1"> <thead> <tr> <th>Birdie Code Configuration</th> <th>Default Country Support</th> <th>Country Code(zz)</th> <th>Country ID String (ccc)</th> </tr> </thead> <tbody> <tr> <td>-001</td> <td>North America</td> <td>19</td> <td>NA</td> </tr> <tr> <td>-002</td> <td>Japan</td> <td>10</td> <td>JPN</td> </tr> <tr> <td>-003</td> <td>APD</td> <td>14</td> <td>SNG</td> </tr> </tbody> </table> <p>9: Returns 2 or 3 character country ID string and 1 to 2 character version of country parameter table. (ie. ccc Ver. v).</p>	Birdie Code Configuration	Default Country Support	Country Code(zz)	Country ID String (ccc)	-001	North America	19	NA	-002	Japan	10	JPN	-003	APD	14	SNG
Birdie Code Configuration	Default Country Support	Country Code(zz)	Country ID String (ccc)														
-001	North America	19	NA														
-002	Japan	10	JPN														
-003	APD	14	SNG														
Ln	<p>Monitor Speaker Volume. Ln sets the speaker volume to low, medium, or high.</p> <p>0: Selects low volume. 1: Selects low volume. 2: Selects medium volume (default). 3: Selects high volume.</p>																
Mn	<p>Monitor Speaker Mode. Mn turns the speaker on or off.</p> <p>0: The speaker is off 1: The speaker is on until the modem detects the carrier signal (default) 2: The speaker is always on when modem is off-hook. 3: The speaker is on until the carrier is detected, except while dialing.</p>																
Nn	<p>Modulation Handshake. Nn controls whether or not the local modem performs a negotiated handshake at connection time with the remote modem when the communication speed of the two modems is different. The N command affects the initial physical layer connection only. It does not affect subsequent speed changes made by V.32bis or MNP class 10 operation.</p> <p>0: When originating or answering, this is for handshake only at the communication standard specified by S37 and the ATB command. 1: When originating or answering, begin the handshake only at the communication standard specified by S37 and the ATB command. During handshake, fallback to a lower speed may occur (default).</p>																

Continued

Table C-1, Modem Commands, Continued

Command	Description
On	<p>Return On-line to Data Mode.</p> <p>0: If the modem is in the on-line command state, the O0 command causes it to go to the on-line state of the previously established connection. If the modem is off hook in the idle (off-line command) state, then the O0 command causes it to go to the handshaking state. Originate or answer mode is determined from the last D or A command, or R dial modifier that was selected. If the modem is on hook in the idle state, or if the modem is a test state, then the "ERROR" result code is returned, and no action is taken.</p> <p>1: If the modem is in the on-line command state, the O1 command causes it to go to the on-line state of the previously established connection, and retrain its adaptive equalizer (if applicable). If the modem is off hook in the idle (off-line command) state, then the O1 command causes it to go to the handshaking state. Originate or answer mode is determined from the last D or A command, or R dial modifier that was selected. If the modem is on hook in the idle state, or if the modem is a test state, then the "ERROR" result code is returned, and no action is taken</p> <p>3: If the modem is in the on-line command state, the O3 command causes it to go to the on-line state of the previously established connection, and issue a rate re negotiation sequence (if applicable). If the modem is off hook in the idle (off-line command) state, then the O3 command causes it to go to the handshaking state. Originate or answer mode is determined from the last D or A command, or R dial modifier that was selected. If the modem is on hook in the idle state, or if the modem is a test state, then the "ERROR" result code is returned, and no action is taken</p> <p>Also note that as the O command returns the modem to the online state, the protocol, compression, and connect message (as enabled by the W command and S95) will be displayed as if the connection was just being made.</p>
P	Select Pulse Dialing. P will apply to all subsequent D commands, until altered by the T command or the T dial modifier. Note that P is both a command and a dial modifier.
Qn	<p>Result Code Control. Result codes are informational messages sent from the modem and displayed on your monitor. Basic result codes are OK, CONNECT, RING, NO CARRIER, and ERROR. The ATQ command allows the user to turn result codes on or off.</p> <p>0: Enables modem to send result codes to the computer (default).</p> <p>1: Disables modem from sending result codes to the computer.</p>
Sr	<p>Select S-register r. Sr is the command to query or write to the selected register.</p> <p>Sr=n: Select S-register r, and write value n to S-register r. Limited to writeable S-registers.</p> <p>Sr?: Select S-register r, read and report its value.</p>
T	Select Tone Dialing. T is both a command and a dial modifier. Applies to all subsequent D commands, until modified by the P command or the P dial modifier. This command instructs the modem to send DTMF tones while dialing. This is the default setting.
Vn	<p>DCE Response Format. Vn controls whether result codes (including call progress and negotiation progress messages) are displayed as words or their numeric equivalents.</p> <p>0: Displays result codes as digits.</p> <p>1: Displays result codes as text (default).</p>
Wn	<p>Result Code Option.</p> <p>0: CONNECT result code reports DTE speed. Disable protocol result code.</p> <p>1: CONNECT result code reports DTE speed. Enable protocol result code</p> <p>2: CONNECT result code reports DCE speed. Enable protocol result codes (default).</p>

Continued

Table C-1, Modem Commands, *Continued*

Command	Description																											
Xn	<p>Result Code Selection and Call Progress Monitoring. Xn enables tone detection options used in the dialing process. As these functions are chosen, the modem chip set's result codes are also affected. Therefore, this command is frequently used to control the modem chip set's responses. The primary function of this control is to control the modem chip set's call response capabilities.</p> <table border="1"> <thead> <tr> <th>Ext. Result Code</th> <th>Dial Tone Detect</th> <th>Busy Tone Detect</th> </tr> </thead> <tbody> <tr> <td>X0: Disable</td> <td>Disable</td> <td>Disable</td> </tr> <tr> <td>X1: Enable</td> <td>Disable</td> <td>Disable</td> </tr> <tr> <td>X2: Enable</td> <td>Enable</td> <td>Disable</td> </tr> <tr> <td>X3: Enable</td> <td>Disable</td> <td>Enable</td> </tr> <tr> <td>X4: Enable</td> <td>Enable</td> <td>Enable (Default)</td> </tr> <tr> <td>X5: Enable</td> <td>Enable</td> <td>Enable</td> </tr> <tr> <td>X6: Enable</td> <td>Enable</td> <td>Enable</td> </tr> <tr> <td>X7: Disable</td> <td>Enable</td> <td>Enable</td> </tr> </tbody> </table>	Ext. Result Code	Dial Tone Detect	Busy Tone Detect	X0: Disable	Disable	Disable	X1: Enable	Disable	Disable	X2: Enable	Enable	Disable	X3: Enable	Disable	Enable	X4: Enable	Enable	Enable (Default)	X5: Enable	Enable	Enable	X6: Enable	Enable	Enable	X7: Disable	Enable	Enable
Ext. Result Code	Dial Tone Detect	Busy Tone Detect																										
X0: Disable	Disable	Disable																										
X1: Enable	Disable	Disable																										
X2: Enable	Enable	Disable																										
X3: Enable	Disable	Enable																										
X4: Enable	Enable	Enable (Default)																										
X5: Enable	Enable	Enable																										
X6: Enable	Enable	Enable																										
X7: Disable	Enable	Enable																										
Extended Result Codes	<p>Disabled: Displays only the basic result codes OK, CONNECT, RING, NO CARRIER, and ERROR</p> <p>Enabled: Displays basic result codes, along with the connect message and the modem's date, rate, and an indication of the modem's error correction and data compression operation</p>																											
Dial Tone Detect	<p>Disabled: The modem dials a call regardless of whether it detects a dial tone. The period of time the modem waits before dialing is specified in register S6.</p> <p>Enabled: The modem dials only upon detection of a dial tone, and disconnects the call if the dial tone is not detected within 10 seconds.</p>																											
Busy Tone Detect	<p>Disabled: The modem ignores any busy tones it receives.</p> <p>Enabled: The modem monitors for busy tones.</p>																											
Yn	<p>Long Space Disconnect. Long space disconnect is always disabled.</p> <p>0: Disable long space disconnect (default).</p> <p>1: Enable long space disconnect. NOT SUPPORTED</p>																											
Zn	<p>Recall Stored Profile. Zn instructs the modem chip set to go on-hook and restore the profile saved by the last &W command. Either Z0 or Z1 restores the same single profile.</p> <p>0: Recall user profile.</p> <p>1: Recall user profile.</p>																											

Table C-2
AT Commands

Command	Description
&Bn	V.32 Auto Retrain. This modem always auto retrains. 0: Disable V.32 auto retrain—NOT SUPPORTED 1: Enable V.32 auto retrain (default)
&Cn	Data Carrier Detect (DCD) Control. Data Carrier Detect is a signal from the modem to your computer indicating that the carrier signal is being received from a remote modem. DCD normally turns off when the modem no longer detects the carrier sign. This command controls the modem's usage of the DCD pin of the DTE interface. 0: Carrier detect always "ON" 1: Carrier detect "ON" only when carrier is present (Default).
&Dn	Data Terminal Ready (DTR) Control. &Dn controls the modem's usage of the DTR pin of the DTE interface. 0: Ignore. The modem ignores the true status of DTR and treats it as always on. This should only be used if your computer does not provide DTR to the modem. 1: If the DTR signal is not detected while in on-line data mode, the modem enters command mode, issues OK result code, and remains connected. 2: If the DTR signal is not detected while in on-line data mode, the modem disconnects (default). 3: Reset on the on-to-off DTR transition.
&F	Load ROM Default Settings. &Fn loads the configuration stored and programmed at the factory. This operation replaces all of the command options and the S-register settings in the active configuration with factory values. This command is allowed only in the off-line command state and will return an ERROR result code if entered while on-line. To load the factory settings, this command must be issued by itself. 0: Restore factory defaults.
&Gn	V.22bis Guard Tone Control. &Gn determines which guard tone, if any, to transmit while transmitting in the high band (answer mode). This command is only used in V.22 and V.22bis mode. This option is not used in North America and is for international use only. 0 Guard tone disabled (default). 1: Sets guard tone to 550Hz. 2: Sets guard tone to 1800Hz
&Jn	Auxiliary Relay option. 0: The auxiliary relay is never closed (Default). 1: NOT SUPPORTED, responds ERROR
&Kn	Local Flow Control Selection. 0: Disable flow control. Same as \Q0 1: Reserved 2: Reserved 3: Enables hardware flow control (RTS/CTS). Same as \Q3 (default). 4: Enable software flow control (XON/XOFF). Same as \Q1.
&Mn	Asynchronous Communications Mode. 0: Asynchronous mode (default). 1: Reserved 2: Reserved 3: Reserved 4: Reserved

Continued

Table C-2, AT Commands, Continued

Command	Description
&P	Pulse Dial Make/Break Ratio Selection. Non-adjustable in some countries. In those countries the &P command shall be accepted and ignored. This command is effective only for Japan. 0: Make/break ratio 34/66% (default) 1: Make/break ratio 33/66%
&Qn	Asynchronous Communications Mode. This setting also affects the usage of the DCD, DTR, CTS, and DSR signals in the DTE interface. 0: Asynchronous Mode, buffered. Same as \N0 or \N1 1: Reserved 2: Reserved 3: Reserved 4: Reserved 5: Enables error control mode, same as \N3. Same as \N3. (Default) 6: Selects asynchronous mode with Automatic Speed Buffering, ame as \N0. 7: Reserved 8: MNP error control mode. If an MNP error control protocol is not established, the modem will fall back according to the current user setting in S36. 9: V.42 or MNP error control mode. If neither error control protocol is established, the modem will fallback according to the current user setting in S36.
&Sn	Data Set Ready (DSR) Selection. &Sn selects DSR action. 0: DSR always ON (default). 1: DSR is OFF when the modem is in the idle state, and when the modem is in a test mode. DSR circuit is turned ON at the start of the handshaking process. DSR is turned off when the hangup process is started.
&Tn	Self-Test Commands. &Tn allows the user to perform diagnostic tests on the modem. These tests can help to isolate problems when experiencing periodic data loss or random errors. 0: Abort. Stops any test in progress. 1: Local analog loop. This test verifies modem operation as well as the connection between modem and computer. Any data entered at the local DTE is modulated, then demodulated and returned to the local DTE. To work properly, the modem must be off-line. 3: Begin digital loopback. &T3 is not allowed if an error control connection is in progress. 6: Remote digital loopback test. This test can verify the integrity of the local modem, the communications link, and the remote modem. Any data entered at the local DTE is sent to and returned from, the remote modem. To work properly, the modems must be on-line with error control established.
&V	View Active Configuration and Stored Profile. &V is used to display the active profiles. 0: View active and store profile. 1: Display active profile and stored profile.
&Wn	Store Current Configuration. &Wn stores certain command options and S-register values into the modem's nonvolatile memory. The ATZ command or a power-up reset of the modem restores this profile. 0: Save active profile to user profile. 1: Not Supported. Will generate an ERROR.
&Yn	Designate Default User Profile. &Yn selects the user profile to be loaded upon power-up (or hardware reset). This command does not change the behavior of the modem but is included for compatibility with applications that issue the &Y0 command. 0: Select stored profile 0 1: Selects user profile 1(this generates an ERROR)

Continued

Table C-2, AT Commands, *Continued*

Command	Description
&Zn=s	<p>Store Telephone Number. &Zn=s stores a 40 character string, retrievable by using the ATDS=n command. Assumes location 0 if n is omitted. When used, the &Z command must be the last command on the command line.</p> <p>) : Store s in location 0 1: Store s in location 1 2: Store s in location 2 3: Store s in location 3</p>
\G	<p>Modem Port Flow Control. Applies to normal (ASB) mode only.</p> <p>0: Returns and "OK" for compatibility (default). 1: NOT SUPPORTED responds ERROR</p>
\J	<p>Adjust Bits/s Rate Control. When this feature is enabled, the modem emulates the behavior of modems that force the DTE interface to the line speed (even for error control connections). This feature will help (but not guarantee) to prevent data loss is one or both DTE interfaces involved do not have flow control.</p> <p>0: Turn off feature (default). 1: Turn on feature.</p>
\K	<p>Set Break Control. /K determines how the modem processes a Break signal received from the local DTE during a connection (online).</p> <p>0: Reserved, returns ERROR. 1: Reserved, returns ERROR. 2: Reserved, returns ERROR. 3: Reserved, returns ERROR. 4: Reserved, returns ERROR. 5: Modem sheds the break to the remote modem in sequence with the transmitted data, non-destructive/non-expedited (default).</p>
\Nn	<p>Error Control Mode Selection. \Nn determines the type of error control used by the modem when sending or receiving data.</p> <p>0: Selects normal (speed buffering) mode. No error control (same as &Q6). 1: Selects direct (pass through) mode. 2: <i>MNP</i>* or disconnect mode. The modem attempts to connect using MNP 2—4 error control procedures. If this fails, the modem disconnects. This is also known as MNP reliable mode. 3: V.42, <i>MNP</i>, or buffer (default). The modem attempts to connect in V.42 error control mode. If this fails, the modem attempts to connect in <i>MNP</i> mode. If this fails, the modem connects in buffer mode and continues operation. This is also known as V.42/<i>MNP</i> auto reliable mode (same as &Q5). 4: V.42 or disconnect. The modem attempts to connect in V.42 error control mode. If this fails, the call will be disconnected. 5: V.42. <i>MNP</i> or buffer (same as \N3). 7: V.42. <i>MNP</i> or buffer (same as \N3).</p>
\Q	<p>Local Flow Control Selection. Also controllable via &K.</p> <p>0: Disable flow control. Same as &K0. 1: XON/XOFF software flow control. Same as &K4. 2: CTS-only flow control. This is not supported and the response is ERROR. 3: Hardware flow control (RTS/CTS) (default). Same as &K3.</p>

Continued

Table C-2, AT Commands, Continued

Command	Description
\Tn	Inactivity Timer. \Tn specifies the length of time (in minutes) that the modem will wait before disconnecting when no data is sent or received. A setting of zero disables the timer. Alternatively, this timer may be specified in register S30. Allowable range and default are country-specific. 0: Inactivity timer disabled (default). 1-255: Inactivity time in minutes. *MNP is a registered Trademark of Microcom
\Vn	Protocol Result Code. Controls whether the string /ARQ is appended to the verbose CONNECT message if a protocol is in use. May also be controlled with bit 1 of S95. 0: Disable protocol result code appended to DCE speed. 1: Enable protocol result code appended to DCE speed (default).
\Xn	XON/XOFF Pass Through. When using XON/XOFF flow control, controls whether the flow control characters are also sent to the remote modem. 0: Process flow control characters locally. (default) 1: Process flow control characters locally, and pass them through to the remote modem so that they can process the characters. NOT SUPPORTED responds ERROR
&&C	Read from /Write to DSP Register. &&C<loc>,<val>: Write <val> to the DSP register at <loc> &&C<loc> Read from the DSP register at <loc>
&&L	Line to Line Loopback
&&R	Write to/Read from DSP RAM Location. AT&&R<loc>,<val>: Writes the value <val> to DSP RAM location <loc> AT&&R<loc>: Reads from location <loc>.
+FCLASS	Service Class Selection. This command sets the modem for class n operation. 000: data mode (default) 001: FAX class 1 008: voice mode Command options: +FCLASS=0 Select data mode. +FCLASS=1 Select Facsimile Class 1. +FCLASS=8 Select voice mode. +FCLASS? Causes the modem to display the current setting. +FCLASS=? Causes the modem to display the classes it supports.
-Cn	Data Calling Tone. Data Calling Tone is a tone of a certain frequency and cadence as specified in V.25 which allows remote Data/FAX/Voice discrimination. The frequency is 1300 Hz with a cadence of .5 s on and 2 s off. 0: Disabled (default). 1: Enabled.
%B	View Numbers in Blacklist. If blacklisting is in effect, this command displays the numbers for which the last call attempted in the past two hours failed. The ERROR result code appears in countries that do not require blacklisting.

Continued

Table C-2, AT Commands, Continued

Command	Description
%Cn	Data Compression Control. %Cn determines the operation of V.42bis and <i>MNP</i> class 5 data compression. Online changes do not take effect until a disconnect occurs first. 0: Disables V.42bis/ <i>MNP</i> 5 data compression. 1: Enables <i>MNP</i> 5 data compression. (default)
+FCLASS=8	Enter Voice Mode. The command AT+FCLASS=8 puts the modem in voice mode. Speakerphone and TAD modes are subsumed under the more general heading of voice mode, and use a particular subset of voice mode commands to implement their respective features and functions. The modem controller will maintain the overall state of the system so as to know when voice commands are issued in the context of using the speakerphone or other voice contexts.
+VIP	Initialize Voice Parameters. The command AT+VIP causes the modem to initialize all the voice parameters to their default values. The command has no effect on the +FCLASS setting
+VDR	Distinctive Ringing & Cadence Report. This command will enable the distinctive ringing feature. This will allow a report of DROF/DRON to follow an exact ring cadence coming over the phone line. +VDR=<enable>,<report> +VDR?: Returns the current values of <enable> and <report> +VDR=? : Queries the DCE for the range of supported distinctive ring configurations
+VGS	(Same as +VGT)
+VGT	Speaker Volume Control. This command will enable the speaker volume control. +VGT=<level> <level> is 0-255 <level>=128: Nominal volume level for sending to speaker +VGT=? Returns the current microphone gain setting. +VGT=? (0-255)
+VGM	(same as +VGR)
+VGR	Receive Gain Selection. This command will enable the receive microphone gain control. <gain> is 0—255: the only useful range is 121—134 <gain>=128: Nominal level for receive gain from microphone Speakerphone mode—This command may be used to control the gain to the remote caller. +VGR? Returns the current receive gain setting. +VGR= (0-255)
+VEM	Event Reporting and Masking. The DTE can use this command to disable anevent report regardless of the DCE state, or of the analog signal source or destination configuration. Mask is Bits 0—33 (i.e., FFFFFFFC). See the IS-101 specification for defined bit values. +VEM=<mask> +VEM? Returns the current values of the mask +VEM=? Queries the DCE for the range of supported service level events
+VIT	DTE/DCE Inactivity Timer. This command sets the DCE's value for the DTE/DCE inactivity timer. The units are in one seconds. +VIT? Returns the current value of the timer +VIT=? Queries the DCE for the range of supported values.

Continued

Table C-2, AT Commands, *Continued*

Command	Description
+VNH	<p>Automatic Hang-up Control. This command causes the DCE to enable or disable automatic hangups in the data and facsimile modes. See the ISO-101 specification for the detailed description of this command and its interaction with the +FCLASS and ATH commands.</p> <p>+VNH=0 The DCE retains automatic hangups (which is the way in the other non-voice modes).</p> <p>+VNH=2 The DCE disables automatic hangups in the other non-voice modes. The DTE only performs a logical hangup (returns the "OK" result code).</p>
+VLS	<p>Analog Source/Destination Selection. This is a general purpose analog source/destination command that attaches various analog devices to the system in voice mode. +<VLS=<label></p> <p>0: Speakerphone off, detach analog devices, DCE on-hook.</p> <p>1: Speakerphone in hold, detach analog devices, DCE off-hook.</p> <p>2: DCE off-hook.</p> <p>3: DCE off-hook.</p> <p>5: Disables/detaches microphone analog source (leaving speaker only) when speakerphone is in operation (phone mute feature).</p> <p>7: Speakerphone on, attach internal speaker and internal microphone, DCE off-hook.</p> <p>AT+VLS?</p> <p>Reports the current analog source/destination configuration, along with a listing of all event codes reported from the modem to the DTE under that configuration. AT+VLS=? Queries the DCE for the range of supported configurations and the list of unsolicited event codes that the modem will report to the DTE under each configuration. For speakerphone, the configurations supported are 0, 5, and 7—as explained above.</p>

Table C-3
FAX Commands

Command	Description																																										
+FCLASS=1	Enter FAX Mode. The command AT+FCLASS=1 puts the modem in FAX mode.																																										
+FTS=<n>	Transmission Silence. This command causes the modem to stop transmitting data and pause for 10 * n ms. At the end of this period, the modem then responds OK . You can specify any number from 0 through 255 as the value of n; for example, a value of 5 specifies a period of 50 ms. This is a FAX command only, responds with the ERROR result code if in data mode.																																										
+FRS=<n>	Receive Silence. This command causes the modem to listen and wait for a 10 * n ms period of silence on the line. At the end of this period, the modem then responds OK . You can specify any number from 0 through 255 as the value of n; for example, a value of 5 specifies a period of 50 ms. This is a FAX command only, responds with the ERROR result code if in data mode. N=0—255 (10 ms intervals)																																										
+FTM=n	FAX data transmit protocol. This command causes the modem to transmit data at the modulation specified by <n>. This is a FAX command only, responds with the ERROR result code if in data mode. The following table shows the values you can enter for this command and the meaning of those values. <table border="1"> <thead> <tr> <th>Command Option</th> <th>Modulation</th> <th>Speed (bits/s)</th> </tr> </thead> <tbody> <tr><td>+FTM=3</td><td>V.21 Channel 2</td><td>300</td></tr> <tr><td>+FTM=24</td><td>V.27ter</td><td>2400</td></tr> <tr><td>+FTM=48</td><td>V.27ter</td><td>4800</td></tr> <tr><td>+FTM=72</td><td>V.29</td><td>7200</td></tr> <tr><td>+FTM=96</td><td>V.29</td><td>9600</td></tr> <tr><td>+FTM=73</td><td>V.17</td><td>7200</td></tr> <tr><td>+FTM=74</td><td>V.17(short train)</td><td>7200</td></tr> <tr><td>+FTM=97</td><td>V.17</td><td>9600</td></tr> <tr><td>+FTM=98</td><td>V.17(short train)</td><td>9600</td></tr> <tr><td>+FTM=121</td><td>V.17</td><td>12000</td></tr> <tr><td>+FTM=122</td><td>V.17(short train)</td><td>12000</td></tr> <tr><td>+FTM=145</td><td>V.17</td><td>14400</td></tr> <tr><td>+FTM=146</td><td>V.17(short train)</td><td>14400</td></tr> </tbody> </table>	Command Option	Modulation	Speed (bits/s)	+FTM=3	V.21 Channel 2	300	+FTM=24	V.27ter	2400	+FTM=48	V.27ter	4800	+FTM=72	V.29	7200	+FTM=96	V.29	9600	+FTM=73	V.17	7200	+FTM=74	V.17(short train)	7200	+FTM=97	V.17	9600	+FTM=98	V.17(short train)	9600	+FTM=121	V.17	12000	+FTM=122	V.17(short train)	12000	+FTM=145	V.17	14400	+FTM=146	V.17(short train)	14400
Command Option	Modulation	Speed (bits/s)																																									
+FTM=3	V.21 Channel 2	300																																									
+FTM=24	V.27ter	2400																																									
+FTM=48	V.27ter	4800																																									
+FTM=72	V.29	7200																																									
+FTM=96	V.29	9600																																									
+FTM=73	V.17	7200																																									
+FTM=74	V.17(short train)	7200																																									
+FTM=97	V.17	9600																																									
+FTM=98	V.17(short train)	9600																																									
+FTM=121	V.17	12000																																									
+FTM=122	V.17(short train)	12000																																									
+FTM=145	V.17	14400																																									
+FTM=146	V.17(short train)	14400																																									
+FTM=?	Reports range of legal values for the +FTM command. The modem reports "3, 24, 48, 72, 73, 74, 96, 97, 98, 121, 122, 145, 146"																																										
+FRM=n	FAX data receive protocol. This command causes the modem to receive data at the modulation specified by <n>. This is a FAX command only, responds with the ERROR result code if in data mode. The following table shows the values you can enter for this command and the meaning of those values. <table border="1"> <thead> <tr> <th>Command Option</th> <th>Modulation</th> <th>Speed (bits/s)</th> </tr> </thead> <tbody> <tr><td>+FRM=3</td><td>V.21 Channel 2</td><td>300</td></tr> <tr><td>+FRM=24</td><td>V.27ter</td><td>2400</td></tr> <tr><td>+FRM=48</td><td>V.27ter</td><td>4800</td></tr> <tr><td>+FRM=72</td><td>V.29</td><td>7200</td></tr> <tr><td>+FRM=96</td><td>V.29</td><td>9600</td></tr> <tr><td>+FRM=73</td><td>V.17</td><td>7200</td></tr> <tr><td>+FRM=74</td><td>V.17(short train)</td><td>7200</td></tr> <tr><td>+FRM=97</td><td>V.17</td><td>9600</td></tr> <tr><td>+FRM=98</td><td>V.17(short train)</td><td>9600</td></tr> <tr><td>+FRM=121</td><td>V.17</td><td>12000</td></tr> <tr><td>+FRM=122</td><td>V.17(short train)</td><td>12000</td></tr> <tr><td>+FRM=145</td><td>V.17</td><td>14400</td></tr> <tr><td>+FRM=146</td><td>V.17(short train)</td><td>14400</td></tr> </tbody> </table>	Command Option	Modulation	Speed (bits/s)	+FRM=3	V.21 Channel 2	300	+FRM=24	V.27ter	2400	+FRM=48	V.27ter	4800	+FRM=72	V.29	7200	+FRM=96	V.29	9600	+FRM=73	V.17	7200	+FRM=74	V.17(short train)	7200	+FRM=97	V.17	9600	+FRM=98	V.17(short train)	9600	+FRM=121	V.17	12000	+FRM=122	V.17(short train)	12000	+FRM=145	V.17	14400	+FRM=146	V.17(short train)	14400
Command Option	Modulation	Speed (bits/s)																																									
+FRM=3	V.21 Channel 2	300																																									
+FRM=24	V.27ter	2400																																									
+FRM=48	V.27ter	4800																																									
+FRM=72	V.29	7200																																									
+FRM=96	V.29	9600																																									
+FRM=73	V.17	7200																																									
+FRM=74	V.17(short train)	7200																																									
+FRM=97	V.17	9600																																									
+FRM=98	V.17(short train)	9600																																									
+FRM=121	V.17	12000																																									
+FRM=122	V.17(short train)	12000																																									
+FRM=145	V.17	14400																																									
+FRM=146	V.17(short train)	14400																																									

Continued

Table C-3, FAX Commands, *Continued*

Command	Description																																										
+FRM=?	Reports range of legal values for the +FRM command. The modem reports "3, 24, 48, 72, 73, 74, 96, 97, 98, 121, 122, 145, 146"																																										
+FTH=n	<p>FAX HDLC Transmit Carrier <n>. This command causes the modem to transmit data framed in the HDLC protocol at the modulation specified by <n>. This is a FAX command only, responds with the ERROR result code if in data mode. The following table shows the values you can enter for this command and the meaning of those values.</p> <table border="1"> <thead> <tr> <th>Command Option</th> <th>Modulation</th> <th>Speed (bits/s)</th> </tr> </thead> <tbody> <tr><td>+FTH=3</td><td>V.21 Channel 2</td><td>300</td></tr> <tr><td>+FTH=24</td><td>V.27ter</td><td>2400</td></tr> <tr><td>+FTH=48</td><td>V.27ter</td><td>4800</td></tr> <tr><td>+FTH=72</td><td>V.29</td><td>7200</td></tr> <tr><td>+FTH=96</td><td>V.29</td><td>9600</td></tr> <tr><td>+FTH=73</td><td>V.17</td><td>7200</td></tr> <tr><td>+FTH=74</td><td>V.17(short train)</td><td>7200</td></tr> <tr><td>+FTH=97</td><td>V.17</td><td>9600</td></tr> <tr><td>+FTH=98</td><td>V.17(short train)</td><td>9600</td></tr> <tr><td>+FTH=121</td><td>V.17</td><td>12000</td></tr> <tr><td>+FTH=122</td><td>V.17(short train)</td><td>12000</td></tr> <tr><td>+FTH=145</td><td>V.17</td><td>14400</td></tr> <tr><td>+FTH=146</td><td>V.17(short train)</td><td>14400</td></tr> </tbody> </table>	Command Option	Modulation	Speed (bits/s)	+FTH=3	V.21 Channel 2	300	+FTH=24	V.27ter	2400	+FTH=48	V.27ter	4800	+FTH=72	V.29	7200	+FTH=96	V.29	9600	+FTH=73	V.17	7200	+FTH=74	V.17(short train)	7200	+FTH=97	V.17	9600	+FTH=98	V.17(short train)	9600	+FTH=121	V.17	12000	+FTH=122	V.17(short train)	12000	+FTH=145	V.17	14400	+FTH=146	V.17(short train)	14400
Command Option	Modulation	Speed (bits/s)																																									
+FTH=3	V.21 Channel 2	300																																									
+FTH=24	V.27ter	2400																																									
+FTH=48	V.27ter	4800																																									
+FTH=72	V.29	7200																																									
+FTH=96	V.29	9600																																									
+FTH=73	V.17	7200																																									
+FTH=74	V.17(short train)	7200																																									
+FTH=97	V.17	9600																																									
+FTH=98	V.17(short train)	9600																																									
+FTH=121	V.17	12000																																									
+FTH=122	V.17(short train)	12000																																									
+FTH=145	V.17	14400																																									
+FTH=146	V.17(short train)	14400																																									
+FTH=?	Reports range of legal values for the +FTH command. The modem reports "3, 24, 48, 72, 73, 74, 96, 97, 98, 121, 122, 145, 146"																																										
+FRH=n	<p>FAX HDLC Receive Carrier <n>. This command causes the modem to receive data framed in the HDLC protocol at the modulation specified by <n>. This is a FAX command only, responds with the ERROR result code if in data mode. The following table shows the values you can enter for this command and the meaning of those values.</p> <table border="1"> <thead> <tr> <th>Command Option</th> <th>Modulation</th> <th>Speed (bits/s)</th> </tr> </thead> <tbody> <tr><td>+FRH=3</td><td>V.21 Channel 2</td><td>300</td></tr> <tr><td>+FRH=24</td><td>V.27ter</td><td>2400</td></tr> <tr><td>+FRH=48</td><td>V.27ter</td><td>4800</td></tr> <tr><td>+FRH=72</td><td>V.29</td><td>7200</td></tr> <tr><td>+FRH=96</td><td>V.29</td><td>9600</td></tr> <tr><td>+FRH=73</td><td>V.17</td><td>7200</td></tr> <tr><td>+FRH=74</td><td>V.17(short train)</td><td>7200</td></tr> <tr><td>+FRH=97</td><td>V.17</td><td>9600</td></tr> <tr><td>+FRH=98</td><td>V.17(short train)</td><td>9600</td></tr> <tr><td>+FRH=121</td><td>V.17</td><td>12000</td></tr> <tr><td>+FRH=122</td><td>V.17(short train)</td><td>12000</td></tr> <tr><td>+FRH=145</td><td>V.17</td><td>14400</td></tr> <tr><td>+FRH=146</td><td>V.17(short train)</td><td>14400</td></tr> </tbody> </table>	Command Option	Modulation	Speed (bits/s)	+FRH=3	V.21 Channel 2	300	+FRH=24	V.27ter	2400	+FRH=48	V.27ter	4800	+FRH=72	V.29	7200	+FRH=96	V.29	9600	+FRH=73	V.17	7200	+FRH=74	V.17(short train)	7200	+FRH=97	V.17	9600	+FRH=98	V.17(short train)	9600	+FRH=121	V.17	12000	+FRH=122	V.17(short train)	12000	+FRH=145	V.17	14400	+FRH=146	V.17(short train)	14400
Command Option	Modulation	Speed (bits/s)																																									
+FRH=3	V.21 Channel 2	300																																									
+FRH=24	V.27ter	2400																																									
+FRH=48	V.27ter	4800																																									
+FRH=72	V.29	7200																																									
+FRH=96	V.29	9600																																									
+FRH=73	V.17	7200																																									
+FRH=74	V.17(short train)	7200																																									
+FRH=97	V.17	9600																																									
+FRH=98	V.17(short train)	9600																																									
+FRH=121	V.17	12000																																									
+FRH=122	V.17(short train)	12000																																									
+FRH=145	V.17	14400																																									
+FRH=146	V.17(short train)	14400																																									
+FRH=?	Reports range of legal values for the +FRH command. The modem reports "3, 24, 48, 72, 73, 74, 96, 97, 98, 121, 122, 145, 146"																																										

Index

A

- AC power
 - removal, 7-53
- AC power cord
 - 3-conductor, B-1
 - requirements, B-1
 - spare part number, 4-7, 5-3
- Advanced AT commands,
 - C-5
- audio
 - solving problems, 3-17
 - test error codes, 3-15
- audio board
 - removal, 7-41
 - spare part number, 4-9
- audio cable
 - removal, 7-41
- Automobile adapter
 - spare part number, 4-11
 - specifications, 9-9

B

- base enclosure assembly
 - spare part number, 4-3
- battery charger
 - described, 1-5
 - spare part number, 4-11
 - specifications, 9-10
- battery gauges
 - solving problems, 3-18
- battery pack
 - DualBay removal, 7-8
 - removal, 7-6
 - solving problems, 3-18
 - spare part number, 4-11
 - specifications, 9-7
 - temperatures, 9-7
- beep codes, 3-6

C

- cables and connectors, 6-6
- cables and power cords
 - spare part number, 4-7

- calling for support, 3-7
- CD-ROM drive
 - removal, 7-11
 - solving problems, 3-21
 - specifications, 9-6
 - test error codes, 3-16
- CD-ROM drive cable, spare
 - part number, 4-7
- clock battery removal, 7-21
- clutch covers
 - removal, 7-26
- clutch removal, 7-28
- codes
 - diagnostic error, 3-11
- Compaq Utilities, 3-7
 - Computer Checkup (TEST), 3-7
 - Computer Setup, 3-7
 - create Diagnostics diskette, 3-7
 - manage Diagnostics partition, 3-7
 - running from diskette, 3-7
 - running from hard drive, 3-7
 - View System Information (INSPECT), 3-7
- components
 - bottom, 1-9
 - rear, 1-8
 - right side, 1-7
- computer
 - features, 1-2
 - models, 1-1
 - specifications, 9-2
- Computer Checkup (TEST), 3-8
- computer logo
 - removal, 7-54
- computer options
 - spare part number
 - automobile adapter, 4-11
 - battery pack, 4-11
 - external battery charger, 4-11
 - power cord, 4-11
- Computer Setup, 3-7

- computer undocking, 7-5
- connector pin assignments,
 - A-1
 - expansion, A-4
- convenience base
 - described, 1-4
 - models, 2-1
 - spare part number
 - cables and power cords, 5-3
 - ethernet model, 5-3
 - options, 5-3
 - pass through model, 5-3
 - specifications, 9-8
 - upgrade, 8-2
- convenience base components
 - front and right side, 2-4
 - rear, 2-6
- convenience base serial number, 8-1
- CPU
 - cover spare part number, 4-3

D

- DC-DC converter
 - removal, 7-43
 - spare part number, 4-9
- Design overview
 - computer, 7-3
- diagnostic error codes, 3-11
- dial modifiers, C-11
- disassembly preparation
 - computer, 7-5
- disassembly sequence chart, 7-2
- disconnecting power, 7-5
- diskette drive
 - error codes, 3-13
 - removal, 7-8
 - solving problems, 3-20
 - spare part number, 4-5
 - specifications, 9-5
- display
 - assembly removal, 7-26

.....

- solving problems, 3-28
- spare part number, 4-3
- specifications, 9-3
- display assembly
 - removal, 7-27
- display latches
 - removal, 7-32
- DMA, system, 9-11
- documentation spare part numbers, 4-14
- DualBay device
 - removal, 7-8

E

- electrostatic discharge, 6-1
- Energy star monitor, 3-31
- error codes, 3-4
 - audio test, 3-15
 - CD-ROM test, 3-16
 - diagnostic, 3-11
 - diskette drive test, 3-13
 - hard drive test, 3-13
 - keyboard test, 3-12
 - memory test, 3-12
 - parallel printer test, 3-12
 - pointing device interface test, 3-16
 - processor test, 3-11
 - serial test, 3-13
 - video test, 3-14
- ethernet module
 - installation, 8-2
- external computer components
 - bottom, 1-9
 - front and left side, 1-6
 - rear, 1-8
 - removal, 7-54
 - right side, 1-7
- external connectors
 - BNC, A-2
 - keyboard, A-1
 - MIDI/game, A-1
 - monitor, A-2
 - mouse, A-1
 - parallel, A-3
 - RJ-45, A-2
 - serial, A-3
 - speaker, A-7

- external keyboards, 1-5
- external monitor, 1-5

F

- fan
 - removal, 7-47
- fatal error
 - beep codes, 3-6
 - messages, 3-6
- faxcommands, C-8
- features, 1-2
- feet, removal, 7-54

G

- grounding methods, 6-3

H

- hard drive
 - removal, 7-19
 - solving problems, 3-21
 - spare part number, 4-5
 - specifications, 9-4
 - test error codes, 3-13
- hardware installation,
 - solving problems, 3-22

I

- I/O addresses, 9-12
- I/O fixture connector
 - removal, 7-49
 - spare part number, 4-9
- infrared
 - solving problems, 3-22
- INSPECT, 3-10
 - See also Compaq Utilities, 3-7
- installation
 - battery pack, 7-7
 - memory board, 7-18
- interrupt requests (IRQ)
 - system, 9-11
- IRQ assignments, 9-11

K

- keyboard

- optional, 1-5
- removal, 7-13
- solving problems, 3-23
- spare part number, 4-3
- test error codes, 3-12

L

- LED status board
 - spare part number, 4-9
- LED Status Panel, 7-40
 - removal, 7-40
- lithium clock battery
 - removal, 7-21
- logo
 - removal, 7-54

M

- mass storage devices
 - spare part number, 4-5
 - battery pack, 4-5
 - CD-ROM drive, 4-5
 - diskette drive, 4-5
 - hard drive, 4-5
- memory
 - solving problems, 3-24
 - test error codes, 3-12
- memory board
 - installing, 7-18
 - removal, 7-16
 - spare part number, 4-9
- memory map
 - system, 9-14
- memory options, 1-4
- messages
 - fatal error, 3-6
 - POST, 3-4
 - warning, 3-5
- microphone
 - microphone removal, 7-23
 - microphone/display cable cover removal, 7-23
 - spare part number, 4-7
- miscellaneous parts
 - spare part number
 - AC Power, 4-13
 - fan, 4-13
 - microphone, 4-13

miscellaneous parts kit,
4-13
plastics kit, 4-13
tool kit, 4-13
models, 1-1, 2-1
modem
removal, 7-10
spare part number, 4-9
modem cable
spare part number, 4-7
modem commands, C-1
monitor
optional, 1-5
solving problems, 3-28

N

network interface card
installation, 8-2
nickel metal hydride battery
spare part number, 4-11
numeric keypad, 3-23

O

100BaseT Ethernet upgrade
installation, 8-2
optional boards
spare part number, 4-9
options, 1-4

P

panel lights, 1-10
parallel port
test error codes, 3-12
pass-through connections,
listing, 2-3
passwords
clearing, 3-3
PC Card
solving problems, 3-25
PC Cards
removal, 7-9
PCMCIA
removal, 7-9
pointing device
interface test error codes,
3-16
solving problems, 3-23

pointing devices
optional, 1-5
POST messages, 3-4
power button
removal, 7-36
power cord requirements,
B-1
power cord set
country-specific
requirements for
3-conductor, B-2
general requirements for
3-conductor, B-1
notes for 3-conductor, B-2
spare part number, 4-7, 5-3
power problems
solving, 3-27
power-on password
clearing, 3-3
Power-On Self-Test (POST)
messages, 3-4
preliminary steps
troubleshooting, 3-2
printers
solving problems, 3-28
processor
test error codes, 3-11

R

removal
audio board, 7-41
audio cable, 7-41
battery pack, 7-6
CD-ROM drive, 7-11
clutch covers, 7-26
clutches, 7-28
DC-DC converter, 7-43
display assembly, 7-26,
7-27
display latches, 7-32
DualBay device, 7-8
hard drive, 7-19
I/O fixture connector, 7-49
keyboard, 7-13
LED status panel, 7-40
memory board, 7-16
microphone, 7-23
microphone/display cable
cover, 7-23

modem, 7-10
PCMCIA (PC Cards), 7-9
power button, 7-36
RTC battery, 7-21
speakers, 7-41
Suspend button, 7-37
system board, 7-51
top cover assembly, 7-34
touchpad buttons, 7-38
RTC battery
removal, 7-21
spare part number, 4-7

S

screen
solving problems, 3-28
serial number, 6-6
computer, 7-1
convenience base, 8-1
serial port
test error codes, 3-13
service preliminaries, 6-1
setup password
clearing, 3-3
shipping boxes, spare part
numbers, 4-14
software
backup, 1-3
fulfillment, 1-3
solving problems, 3-30
spare part number
AC power cord, 4-7, 5-3
Automobile adapter, 4-11
battery, 4-11
battery charger, 4-11
cables, 5-3
CD-ROM drive cable, 4-7
convenience base, 5-3
diskette drive, 4-5
documentation, 4-14
external battery charger,
4-11
hard drive, 4-5
Keyboard, 4-3
modem cable, 4-7
power cords, 5-3
shipping boxes, 4-14
tool kit, 4-13
speakers

removal, 7-41
spare part number, 4-3
specifications, 9-1
automobile adapter, 9-9
battery charger, 9-10
battery pack, 9-7
CD-ROM drive, 9-6
computer, 9-2
Convenience Base, 9-8
diskette drive, 9-5
display, 9-3
hard drive, 9-4
standard boards
spare part number, 4-9
status panel lights, 1-10
Suspend button
removal, 7-37
system
DMA, 9-11
I/O address, 9-12
interrupts, 9-11
memory map, 9-14
memory options, 1-4
system board
removal, 7-51
spare part number, 4-9

T

temperatures
battery pack, 9-7
tool kit
spare part number, 4-13

Tools, 6-6
top cover assembly
removal, 7-34
spare part number, 4-3
touch pad buttons, 7-38
removal, 7-38
troubleshooting, 3-1
battery and battery gauge
problems, 3-18
CD-ROM drive problems,
3-21
diskette drive problems,
3-20
display and external
monitor, 3-28
hard drive problems, 3-21
hardware installation, 3-22
infrared connection
problems, 3-22
keyboard, 3-23
memory problems, 3-24
network, 3-33
numeric keypad, 3-23
PC Cards, 3-25
pointing device, 3-23
power, 3-27
preliminary steps, 3-2
printers, 3-28
screen problems, 3-28
software applications, 3-30
solving audio problems,
3-17

solving minor problems,
3-17
without diagnostics, 3-17

U

utilities, 3-7
Computer Checkup
(TEST), 3-8
View System Information
(INSPECT), 3-10

V

video display
removal, 7-26
video test error codes, 3-14
View System Information
(INSPECT), 3-10

W

warning messages, 3-5
Windows 95
recognizing devices, 3-7
running Computer Setup,
3-7